



POWERING INNOVATION THAT DRIVES HUMAN ADVANCEMENT

© 2025 ANSYS, Inc. or its affiliated companies
Unauthorized use, distribution, or duplication is prohibited.

Getting Started with HFSS™: Coax Connector



ANSYS, Inc.
Southpointe
2600 Ansys Drive
Canonsburg, PA 15317
ansysinfo@ansys.com
<https://www.ansys.com>
(T) 724-746-3304
(F) 724-514-9494

Release 2025 R1
January 2025

ANSYS, Inc. and ANSYS
Europe, Ltd. are UL registered
ISO 9001:2015 companies.

Copyright and Trademark Information

© 1986-2025 ANSYS, Inc. Unauthorized use, distribution or duplication is prohibited.

ANSYS, Ansys Workbench, AUTODYN, CFX, FLUENT and any and all ANSYS, Inc. brand, product, service and feature names, logos and slogans are registered trademarks or trademarks of ANSYS, Inc. or its subsidiaries located in the United States or other countries. Icem CFD is a trademark used by ANSYS, Inc. under license. All other brand, product, service and feature names or trademarks are the property of their respective owners. FLEXIm and FLEXnet are trademarks of Flexera Software LLC.

Disclaimer Notice

THIS ANSYS SOFTWARE PRODUCT AND PROGRAM DOCUMENTATION INCLUDE TRADE SECRETS AND ARE CONFIDENTIAL AND PROPRIETARY PRODUCTS OF ANSYS, INC., ITS SUBSIDIARIES, OR LICENSORS. The software products and documentation are furnished by ANSYS, Inc., its subsidiaries, or affiliates under a software license agreement that contains provisions concerning non-disclosure, copying, length and nature of use, compliance with exporting laws, warranties, disclaimers, limitations of liability, and remedies, and other provisions. The software products and documentation may be used, disclosed, transferred, or copied only in accordance with the terms and conditions of that software license agreement.

ANSYS, Inc. and ANSYS Europe, Ltd. are UL registered ISO 9001: 2015 companies.

U.S. Government Rights

For U.S. Government users, except as specifically granted by the ANSYS, Inc. software license agreement, the use, duplication, or disclosure by the United States Government is subject to restrictions stated in the ANSYS, Inc. software license agreement and FAR 12.212 (for non-DOD licenses).

Third-Party Software

See the legal information in the product help files for the complete Legal Notice for Ansys proprietary software and third-party software. If you are unable to access the Legal Notice, please contact ANSYS, Inc.

Conventions Used in this Guide

Please take a moment to review how instructions and other useful information are presented in this documentation.

- Procedures are presented as numbered lists. A single bullet indicates that the procedure has only one step.
- Bold type is used for the following:
 - Keyboard entries that should be typed in their entirety exactly as shown. For example, “**copy file1**” means you must type the word **copy**, then type a space, and then type **file1**.
 - On-screen prompts and messages, names of options and text boxes, and menu commands. Menu commands are often separated by greater than signs (>). For example, “click **HFSS > Excitations > Assign > Wave Port.**”
 - Labeled keys on the computer keyboard. For example, “Press **Enter**” means to press the key labeled **Enter**.
- Italic type is used for the following:
 - Emphasis.
 - The titles of publications.
 - Keyboard entries when a name or a variable must be typed in place of the words in italics. For example, “**copy filename**” means you must type the word **copy**, then type a space, and then type the name of the file.
- The plus sign (+) is used between keyboard keys to indicate that you should press the keys at the same time. For example, “Press Shift+F1” means to press the **Shift** key and, while holding it down, press the **F1** key also. You should always depress the modifier key or keys first (for example, Shift, Ctrl, Alt, or Ctrl+Shift), continue to hold it/them down, and then press the last key in the instruction.

Accessing Commands: *Ribbons*, *menu bars*, and *shortcut menus* are three methods that can be used to see what commands are available in the application.

- The *Ribbon* occupies the rectangular area at the top of the application window and contains multiple tabs. Each tab has relevant commands that are organized, grouped, and labeled. An example of a typical user interaction is as follows:

"Click **Draw > Line**"



This instruction means that you should click the **Line** command on the **Draw** ribbon tab. An image of the command icon, or a partial view of the ribbon, is often included with the instruction.

- The *menu bar* (located above the ribbon) is a group of the main commands of an application arranged by category such File, Edit, View, Project, etc. An example of a typical user interaction is as follows:

"On the **File** menu, click the **Open Examples** command" means you can click the **File** menu and then click **Open Examples** to launch the dialog box.

- Another alternative is to use the *shortcut menu* that appears when you click the right-mouse button. An example of a typical user interaction is as follows:

"Right-click and select **Assign Excitation > Wave Port**" means when you click the right-mouse button with an object face selected, you can execute the excitation commands from the shortcut menu (and the corresponding sub-menus).

Getting Help: Ansys Technical Support

For information about Ansys Technical Support, go to the Ansys corporate Support website, <http://www.ansys.com/Support>. You can also contact your Ansys account manager in order to obtain this information.

All Ansys software files are ASCII text and can be sent conveniently by e-mail. When reporting difficulties, it is extremely helpful to include very specific information about what steps were taken or what stages the simulation reached, including software files as applicable. This allows more rapid and effective debugging.

Help Menu

To access help from the Help menu, click **Help** and select from the menu:

- **[product name] Help** - opens the contents of the help. This help includes the help for the product and its *Getting Started Guides*.
- **[product name] Scripting Help** - opens the contents of the *Scripting Guide*.
- **[product name] Getting Started Guides** - opens a topic that contains links to Getting Started Guides in the help system.

Context-Sensitive Help

To access help from the user interface, press **F1**. The help specific to the active product (design type) opens.

You can press **F1** while the cursor is pointing at a menu command or while a particular dialog box or dialog box tab is open. In this case, the help page associated with the command or open dialog box is displayed automatically.

Table of Contents

| | |
|--|-------------------|
| Table of Contents | Contents-1 |
| 1 - Introduction | 1-1 |
| 2 - Set Up the Project | 2-1 |
| Set General Options | 2-2 |
| Insert HFSS Design | 2-4 |
| Enable Legacy View Orientations | 2-5 |
| Set Model Units (cm) | 2-7 |
| Verify Solution Type (Terminal) | 2-7 |
| 3 - Create the Model | 3-1 |
| Create Conductor 1 | 3-1 |
| Create Offset Coordinate System | 3-4 |
| Create Conductor Bend | 3-5 |
| Create Conductor 2 | 3-7 |
| Create Second Offset Coordinate System | 3-10 |
| Create Conductor 3 | 3-10 |
| Unite Conductors 1, 2, 3, and Bend | 3-11 |
| Create the Female End | 3-12 |
| Create the Female Bend | 3-15 |
| Create the Male End | 3-16 |
| Unite Female, FemaleBend, and Male | 3-17 |
| Create the Ring | 3-18 |
| Complete the Ring | 3-20 |
| Create the Male Teflon | 3-22 |
| Create the Female Teflon | 3-24 |
| Complete the Vacuum Object | 3-25 |
| Complete the Model | 3-26 |
| Assign Excitation 1 | 3-28 |
| Assign Excitation 2 | 3-30 |

| | |
|--|------------|
| Boundary Display (Optional) | 3-31 |
| 4 - Analyze the Model | 4-1 |
| Add Solution Setup and Frequency Sweep | 4-1 |
| Analyze the Coax Connector | 4-3 |
| Review Solution Data | 4-5 |
| Review the Profile Tab | 4-5 |
| Review the Convergence Tab | 4-7 |
| Review the Matrix Data Tab | 4-8 |
| Review the Mesh Statistics Tab | 4-9 |
| Port Field Display (Optional) | 4-10 |
| Create S-Parameter versus Pass Plot | 4-12 |
| Create S-Parameter (dB) versus Frequency Plot | 4-14 |
| Create S-Parameter (Angle) versus Frequency Plot | 4-16 |
| Create Electric Field Overlay | 4-18 |
| Modify Magnitude of Field Plot | 4-21 |
| Modify Terminal Excitation | 4-22 |
| Animate the Field Plot | 4-23 |
| Net Visualization | 4-24 |
| 5 - Optionally, Restore Current View Orientations | 5-1 |
| Index | 3 |

1 - Introduction

This document is intended as supplementary material to HFSS for beginners and advanced users. It includes instructions to create, simulate, and analyze a right-angle coaxial connector.

Sample Project - Coaxial Connector:

Coaxial connectors can connect co-axial cables with one another or devices for which a signal needs to be carried through co-axial cables.

The following figure illustrates a model of a right-angle coaxial connector to be drawn as part of this exercise.

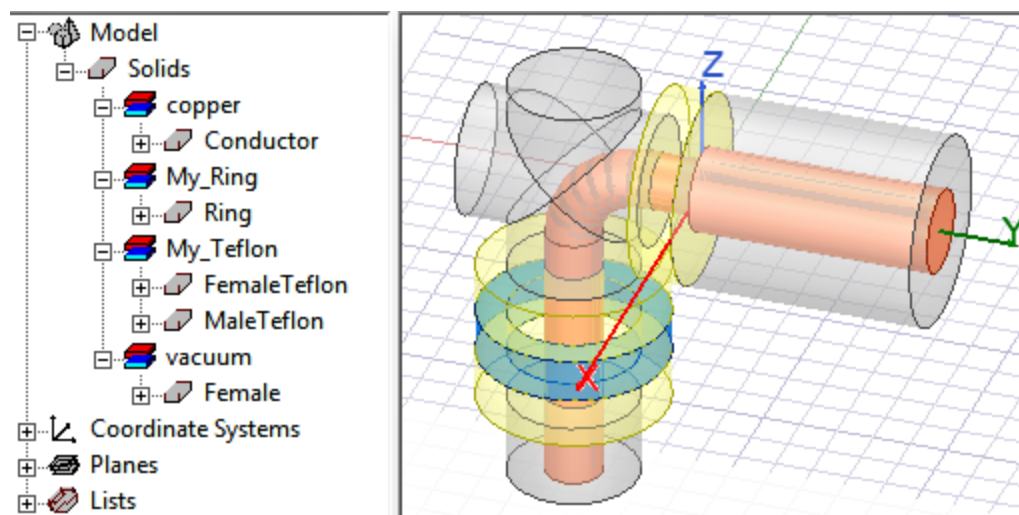

Figure 1-1: Co-axial Connector

HFSS Design Environment:

You will use many features of HFSS to create, analyze, and evaluate this model, as follows:

- 3D solid modeling to design the device
- Define Offset Coordinate Systems
- Use primitives, such as Cylinders and Polylines
- Perform Boolean operations to Unite and Subtract objects
- Assign Excitations
- Analysis a Setup and Fast Frequency Sweep to analyze
- Validate the model
- Create Plots in Cartesian coordinates
- Create Field Overlays to plot electromagnetic fields

- Create 3D Field Plots
- Animate Results
- View the Port Field Display

2 - Set Up the Project

After launching Ansys Electronics Desktop, you will perform the following tasks as part of setting up the project:

- Set Tool Options
- Insert an HFSS Design
- Set Model Units (cm)
- Verify Solution Type (Terminal)

Launch Ansys Electronics Desktop:

For convenience, a shortcut to the *Ansys Electronics Desktop* application is placed on your desktop during program installation. Optionally, you may want to pin the shortcut to your Windows Start Menu too.



1. Double-click **EDT Ansys Electronics Desktop** (or click the same shortcut on your Start Menu) to launch the application.

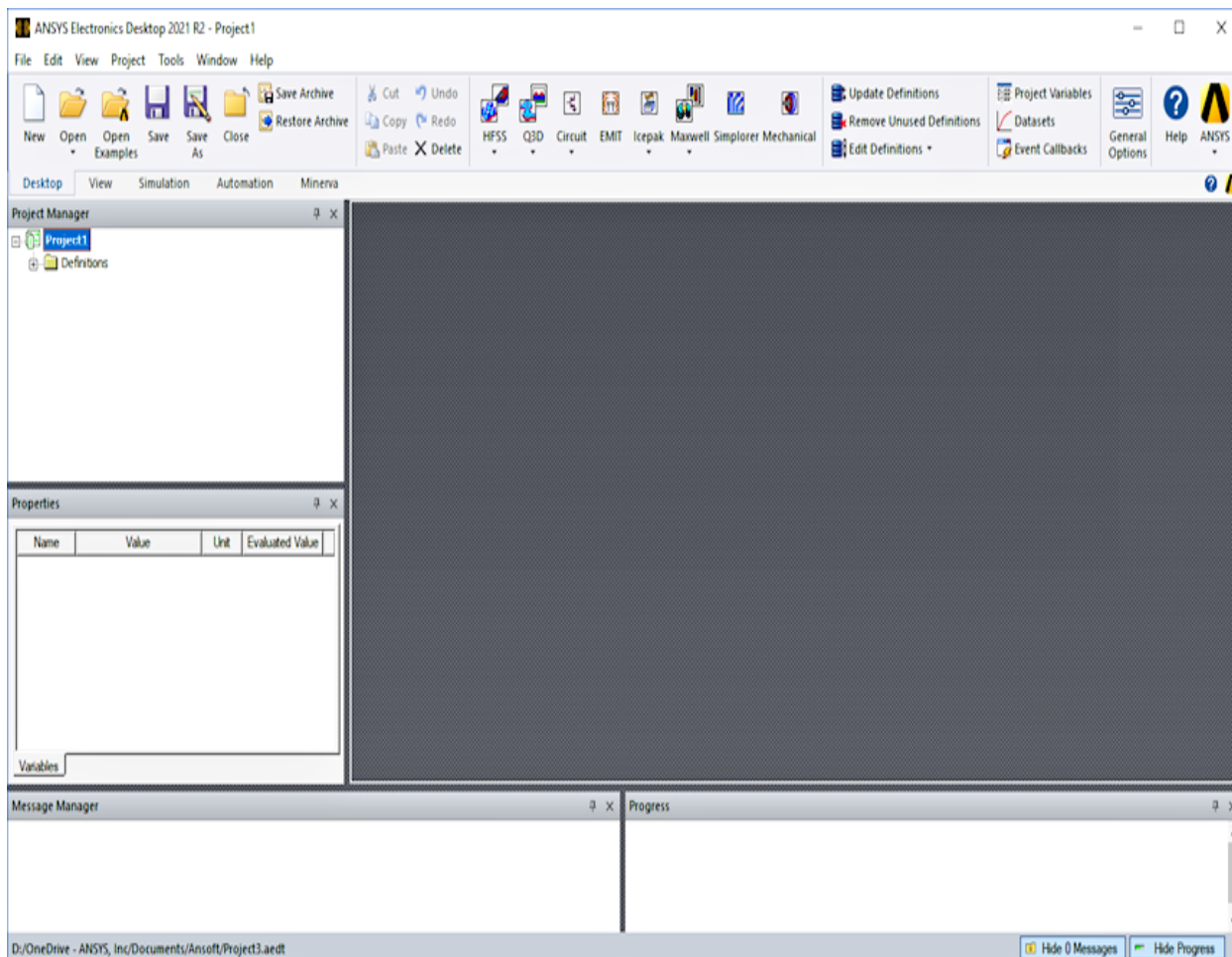



Figure 2-1: Ansys Electronics Desktop

Note:

Refer to the preceding figure. If the **Projectx** folder is missing, click **New** on the **Desktop** ribbon tab to start a new project. This folder will be missing if you already had Electronics Desktop open to work on another project and closed that project without exiting the application. Also, if the *Project Manager* window does not appear, go to the **View** menu and enable it.

Set General Options

1. On the **Desktop** ribbon tab, click  **General Options**.

The *Options* dialog box appears.

2. Click the + symbol by **HFSS** to expand this branch and select **Boundary Assignment**.
3. Ensure all **Boundary Assignment** options are selected, as shown below:

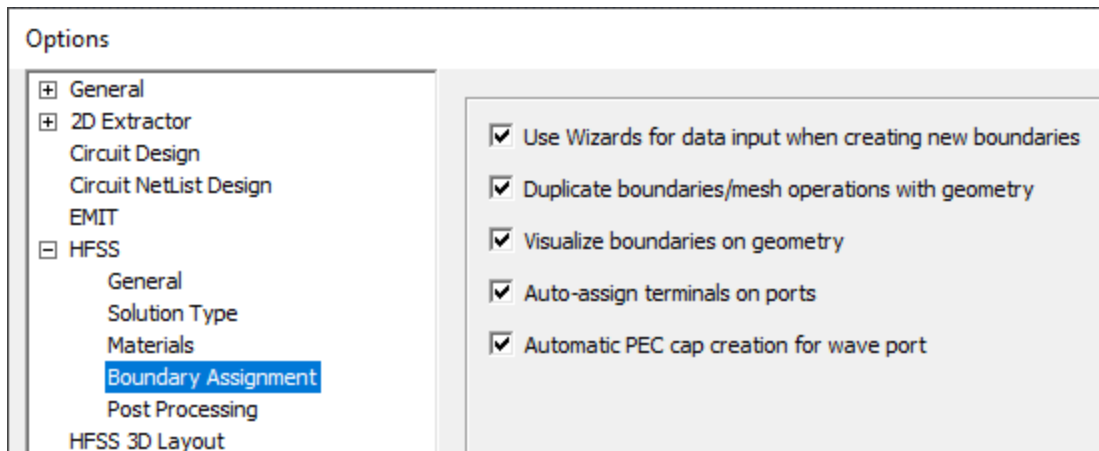

Figure 2-2: HFSS Boundary Assignment Options

4. Click the + symbol by **3D Modeler Options** and select **Drawing**.
 - a. Under *Drawing Data Entry Mode*, ensure that **Point** is selected.
 - b. Select **Automatically cover closed polylines**.
 - c. Select **Edit properties of new primitives**

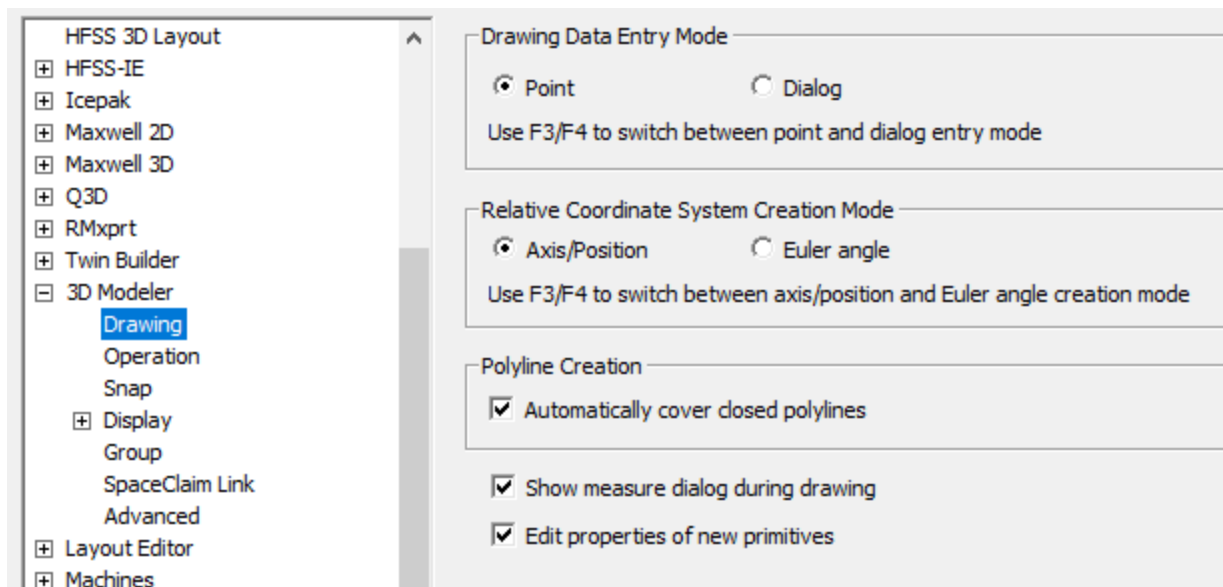

Figure 2-3: 3D Modeler Drawing Options

Note:

The **Edit properties of new primitives** option causes the *Properties* dialog box to appear whenever you create a new object. This option makes it very easy to immediately edit the location, dimensions, coordinate system, material, name, or appearance of new objects.

5. Click **OK** to close the *Options* window.

Insert HFSS Design

Either of the two red-boxed icons in the following figure insert an **HFSS** design into the project. The default action for the **HFSS** drop-down menu is to insert a regular HFSS design. Therefore, clicking the first icon has the same effect as accessing the drop-down menu and clicking the second icon.

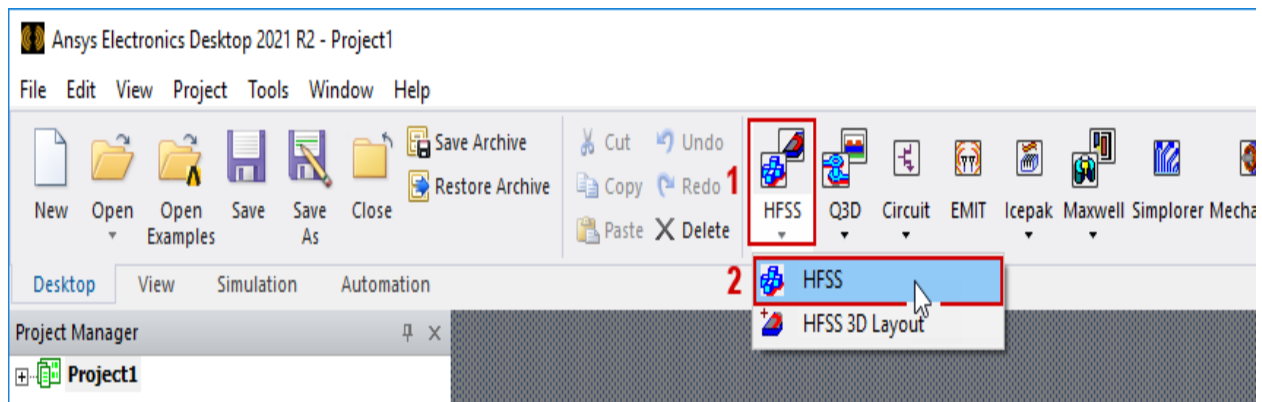

Figure 2-4: Insert HFSS Design

1. Expand the **Projectx** folder at the top of the *Project Manager*.
2. On the **Desktop** ribbon tab, click **HFSS**.

Note:

Adding an HFSS design type modifies the project and, hence, an asterisk appears on **Projectx**.

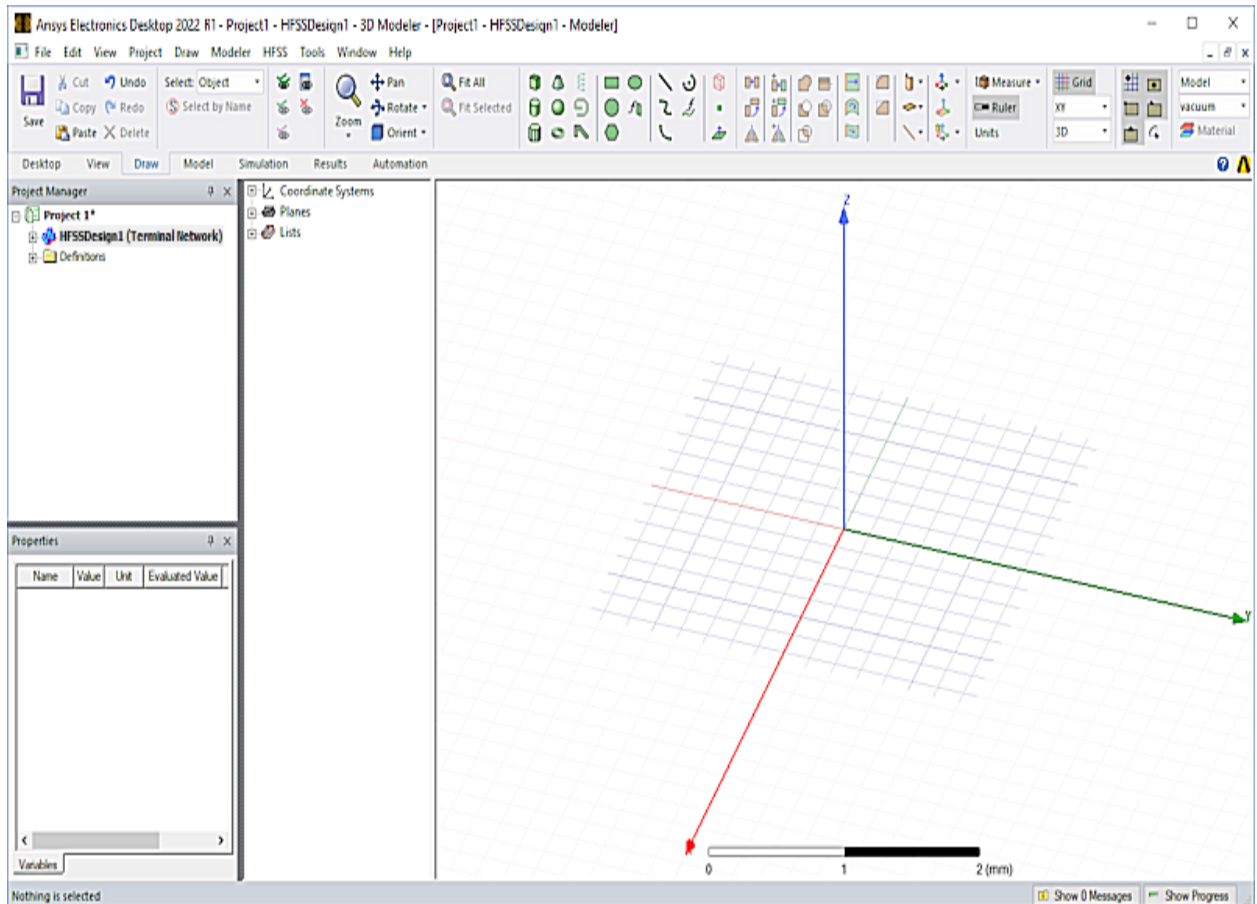



Figure 2-5: HFSSDesign1 Added

3. Click **Projectx**, press **F2**, and rename the project **Coax Connector**.
4.  **Save** your model.

Enable Legacy View Orientations

This getting started guide was created based on standard view orientations that were in effect for version 2023 R2 and earlier of the Ansys Electronics Desktop application. For consistency between your experience and the views and instructions contained in this guide, select the *Enable Legacy View Orientation* option in the 3D UI Options dialog box, as follows:

1. From the menu bar, click **View > Options**.
The *3D UI Options* dialog box appears.
2. Select **Enable Legacy View Orientation**:

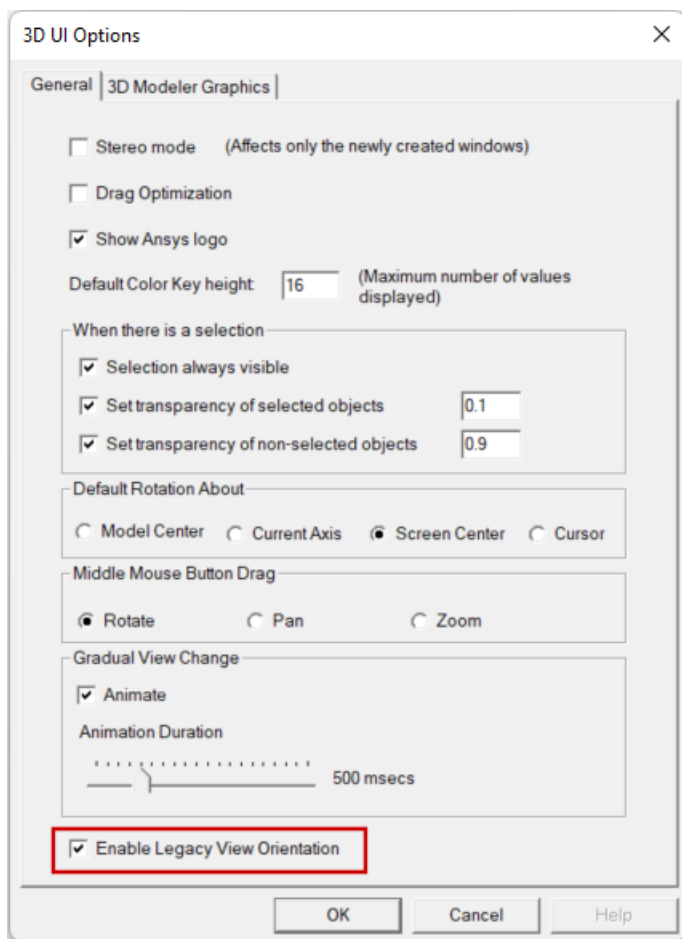

3. Click **OK**.

Changing the view orientation option does not change the model viewpoint that was in effect at the time.

4. On the **Draw** ribbon tab, click  **Orient** to change to the *Trimetric* view, which is the default legacy view orientation.

You do not have to select *Trimetric* from the *Orient* drop-down menu. The default view appears when you click *Orient*.

Although this option can only be accessed once a design is added to a project, it is a global option. Your choice is retained for all future program sessions, projects, and design types that use the 3D Modeler or that produce 3D plots of results.

At the end of this guide, you will be prompted to clear the *Enable Legacy View Orientation* option, if you prefer to use the view orientation scheme implemented for 2024 R1 and newer versions going forward.

For a comparison of the legacy and current view orientations, search for "*View Options: 3D UI Options*" in the HFSS help. Additionally, views associated with **Alt + double-click** zones have

been redefined. The current orientations are shown in the help topic, "*Changing the Model View with Alt+Double-Click Areas.*"

Set Model Units (cm)

Define the model units as follows:

1. On the **Draw** ribbon tab, click **Units**.

The *Set Model Units and Max Extent* dialog box appears.

2. Select **cm** (centimeters) from the **Select units** drop-down menu.

Keep the **Rescale to new units** and **Advanced** options cleared.

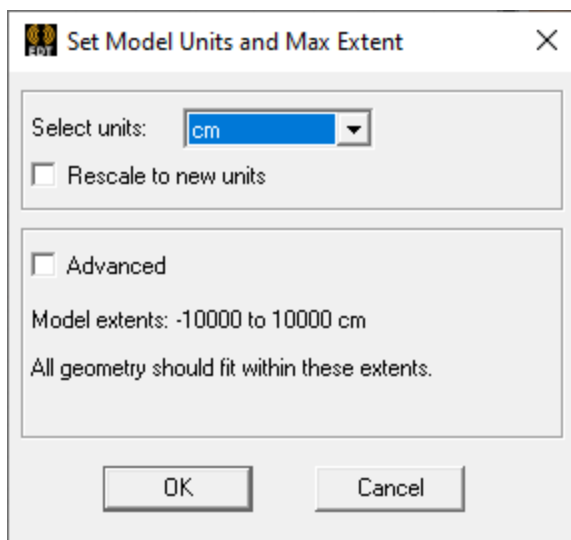

Figure 2-6: Set Model Units Dialog Box

3. Click **OK**.

Verify Solution Type (Terminal)

Specify the design's solution type as follows:

1. In the Project Manager, right-click **HFSSDesign1** and select **Solution Type** from the shortcut menu.

The *Solution Type* dialog box appears.

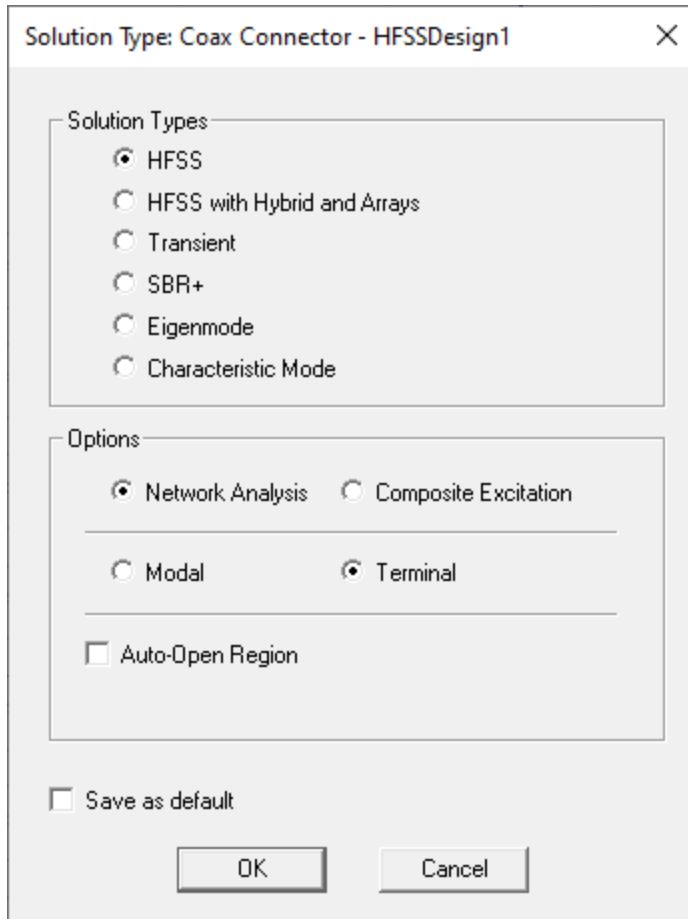

Figure 2-7: Solution Type Dialog Box

2. Ensure that **HFSS** is selected under *Solution Types* and that the selected *Options* are **Network Analysis** and **Terminal**.

These settings are the defaults for a clean program installation, but users can save different defaults if wanted.

3. Click **OK**.

Note:

The Terminal solution type calculates terminal-based S-parameters of multi-conductor transmission line ports. The S-matrix solutions are expressed in terms of terminal voltages and currents.

3 - Create the Model

Outline of the tasks to create the model:

- Define Offset Coordinate Systems to facilitate model construction
- Create copper objects (*Conductor 1, Bend, Conductor 2 and Conductor 3*)
- Unite the copper objects
- Create vacuum objects (*Female End, Female Bend, and Male End*)
- Unite the vacuum objects
- Create a Ring part
- Complete the Ring (subtract the united vacuum part from the Ring)
- Create Teflon parts (*Male Teflon and Female Teflon*)
- Complete the vacuum object (subtract the Teflon parts from the vacuum object)
- Complete the geometry (subtract united copper part from vacuum and Teflon parts)
- Assign excitations
- Verify boundary display (Solver View)

Create Conductor 1

The conductor for this model is made of copper and is comprised of four objects that you will eventually unite into a single part. For convenience, you can set *copper* as the default material before making the first four objects. Then, to create the first conductor object, draw a cylinder of any size freehand in the Modeler window, starting at the global origin, and edit its properties.

1. On the **Draw** ribbon tab, choose **Select** from the *Default Material* drop-down menu:

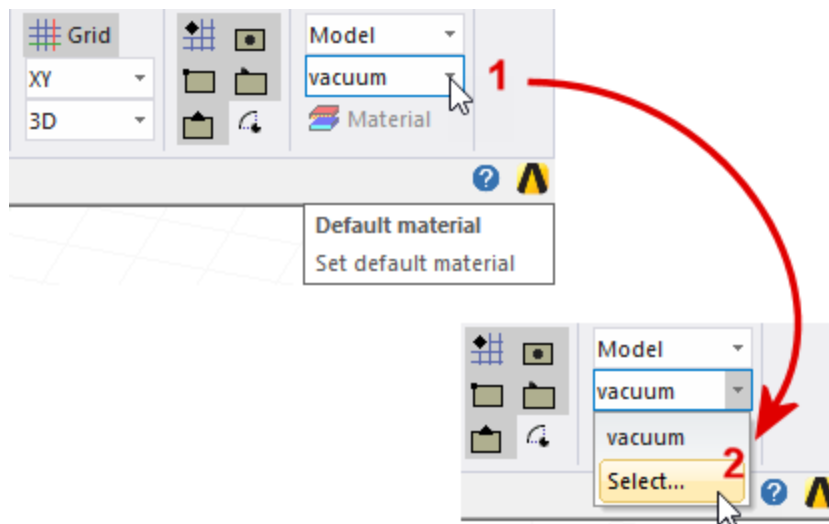



Figure 3-1: Setting the Default Material

The *Select Definition* dialog box opens.

- a. Type **cop** in the **Search by Name** text box, and **copper** will be highlighted in the materials list.
 - b. Click **OK** to make *copper* the default material for new objects.
2. On the **Draw** ribbon tab, click  **Cylinder**.
 3. Click at the global origin to establish the center point of the cylinder base.

The cursor shows a diamond-shaped snapping point indicator when at the origin or any grid points:



Figure 3-2: Snapping Point Indicator (at Origin)

4. Move the cursor along the **xy** plane to form a circle or any size and click the mouse again.

The mini **z** axis for the cylinder height appears.

5. Move the mouse along the mini **z** axis direction and click to complete a cylinder of any height.

The *Properties* dialog box appears.

6. On the **Command** tab of the *Properties* dialog box, edit the fields as shown in the following figure. Then, keep the *Properties* dialog box open when finished.

If you clicked the correct starting point, you should only have to edit the **Radius** and **Height** values. The **Center Position** should already be correct.

| Command | | Attribute | | |
|---------|-------------------|----------------|------|-----------------|
| | Name | Value | Unit | Evaluated Value |
| | Command | CreateCylinder | | |
| | Coordinate Sys... | Global | | |
| | Center Position | 0,0,0 | cm | 0cm, 0cm, 0cm |
| | Axis | Z | | |
| | Radius | 0.152 | cm | 0.152cm |
| | Height | 1.448 | cm | 1.448cm |
| | Number of Seg... | 0 | | 0 |

Figure 3-3: Conductor1, Properties Dialog Box (Command Tab)

- On the **Attribute** tab, change the **Name** to **Conductor1**.

Note:

By default, **Solve Inside** is deselected for metals or highly conductive materials. In such cases, the conductive material is represented by a boundary condition that removes the need to solve inside the material. For most projects, we recommend you use the default setting for *Solve Inside*.

- Select the **Material Appearance** option, if it is not already selected, and click **OK**.

Note:

This option bases the object color and transparency on data from the material library (when available). Use this option so that your model appearance is consistent with the images in this exercise.

- Finally, press **CTRL+D** to fit the view and click in the Modeler window background to clear the current selection.

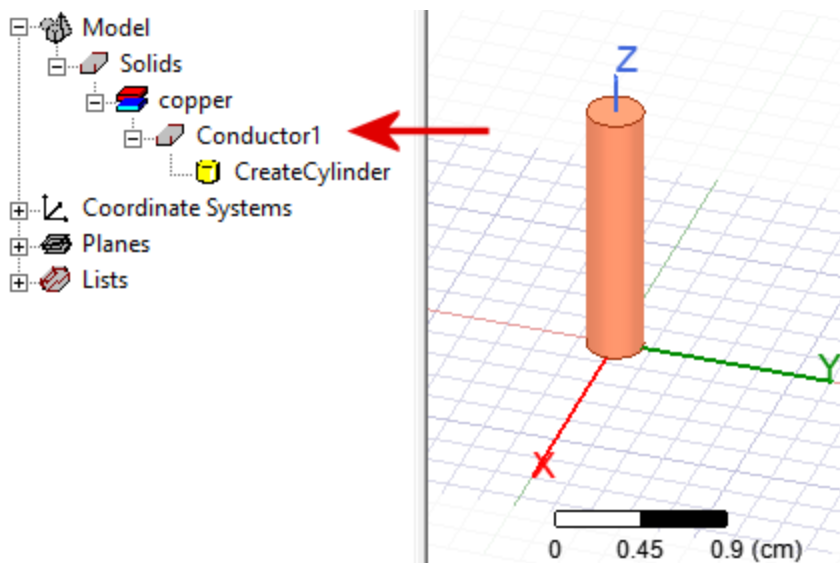

Figure 3-4: Conductor1

Note:

As you continue to build the model, whenever you want to fit the view, press **Ctrl+D**.

Create Offset Coordinate System

To make it easy to create the *Bend* object, create an offset coordinate system (CS) at the top face of *Conductor1*, as follows.

1. On the **Draw** ribbon tab, select **Relative CS > Offset**, as shown in the following figure:

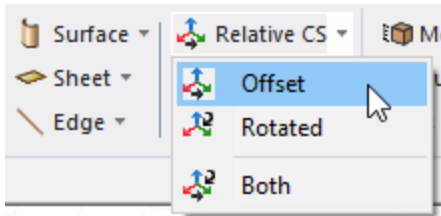

Figure 3-5: Offset Relative CS Command

Note:

Alternatively, you can just click **Relative CS** without accessing the drop-down menu, since *Offset* is the default type of relative CS.

2. Click the center point of the top face of cylinder *Conductor1*. The cursor becomes a sphere at the proper snap point.

As soon as you click the second point, the coordinate system *RelativeCS1* is defined, and the grid and axes move to the top of the cylinder.

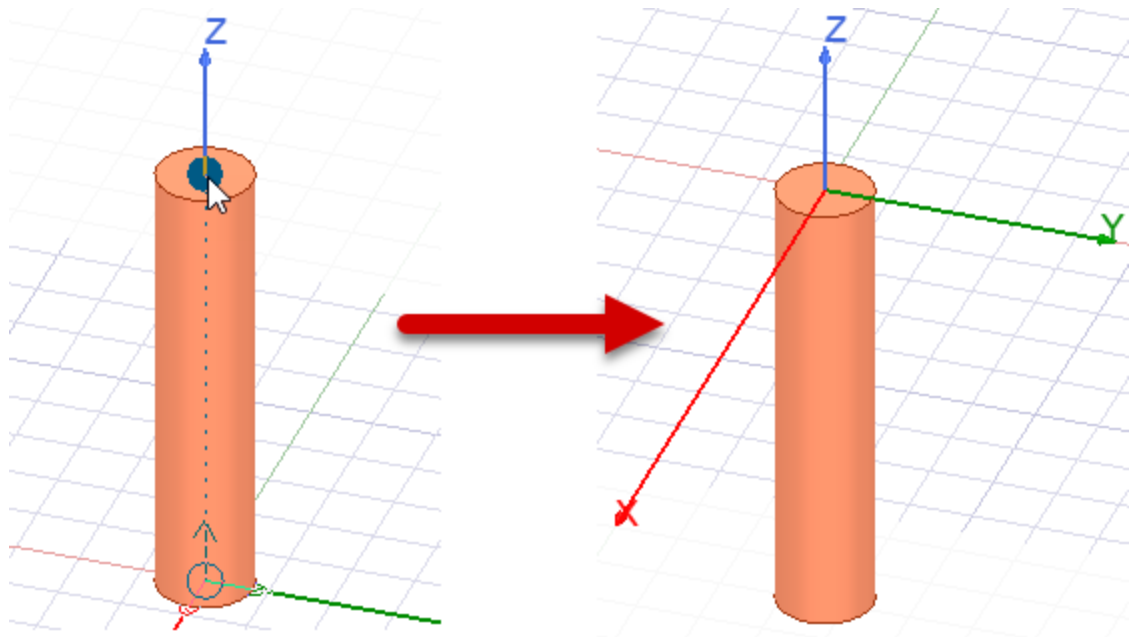

Figure 3-6: Creating the First Offset Coordinate System

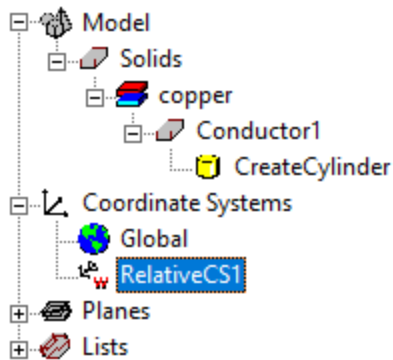

Figure 3-7: *RelativeCS1* in the History Tree

Create Conductor Bend

You will perform the following tasks in this section:

Begin by changing the drawing plane. For convenience, the plane should correspond to the plane of the arc you will draw afterward. This arc defines the path for sweeping a face into a solid (specifically, the conductor bend).

1. On the **Draw** ribbon tab, choose **YZ** from the **Drawing plane** drop-down menu.

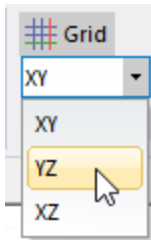



Figure 3-8: Selecting YZ Drawing Plane

The grid is now displayed on the YZ plane of RelativeCS1. You will next draw an arc along this plane to define the sweep path for the bend.

2. On the **Draw** ribbon tab, click  **Draw center point arc**.
3. In the status bar at the bottom of the application, enter the following coordinates (pressing **Tab** to jump into the **X** text box and to cycle between the **X**, **Y**, and **Z** text boxes):
 - **Axis:** X: 0, Y: 0.4, Z: 0, and press **Enter**.
 - **Radial point:** X: 0, Y: 0, Z: 0, and press **Enter**.
 - **Sweep Arc Length:** X: 0, Y: 0.4, Z: 0.4, and press **Enter**.

Note:

If you make a mistake press **Esc** and resume.

- Right-click inside the modeler window and select **Done** from the shortcut menu.

The *Done* command completes the polyline with just the one arc segment.

- Click **OK** to close the *Properties* dialog box that appears.

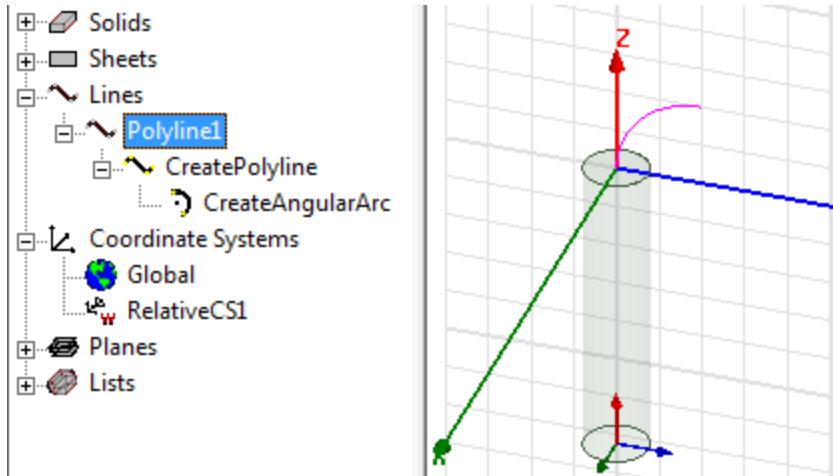

Figure 3-9: Arc Polyline1 Created

- Press **F** to switch to the **Faces Selection Mode**.
- Select the top face of the *Conductor1* cylinder.
- On the **Draw** ribbon tab, click **Surface > Create Object From Face**.
- With the sheet object just created still selected, in the docked *Properties* window, change the **Name** to **Bend** and press **Enter**.
- Press **O** to switch to the **Objects Selection Mode**.

The object just created should still be selected.

- Hold down **Ctrl** and also select the **arc**, *Polyline1*, you drew previously.
- On the **Draw** ribbon tab, click **Sweep along path**.

The *Sweep along path* dialog box appears.

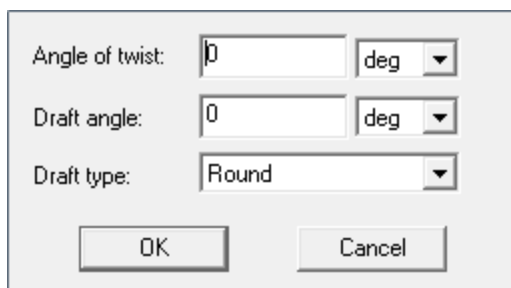

Figure 3-10: Sweep along path Dialog Box

- Click **OK** to complete the sweep with no draft or twist specified (0 degrees for both).

The bend is swept along the path as shown below:

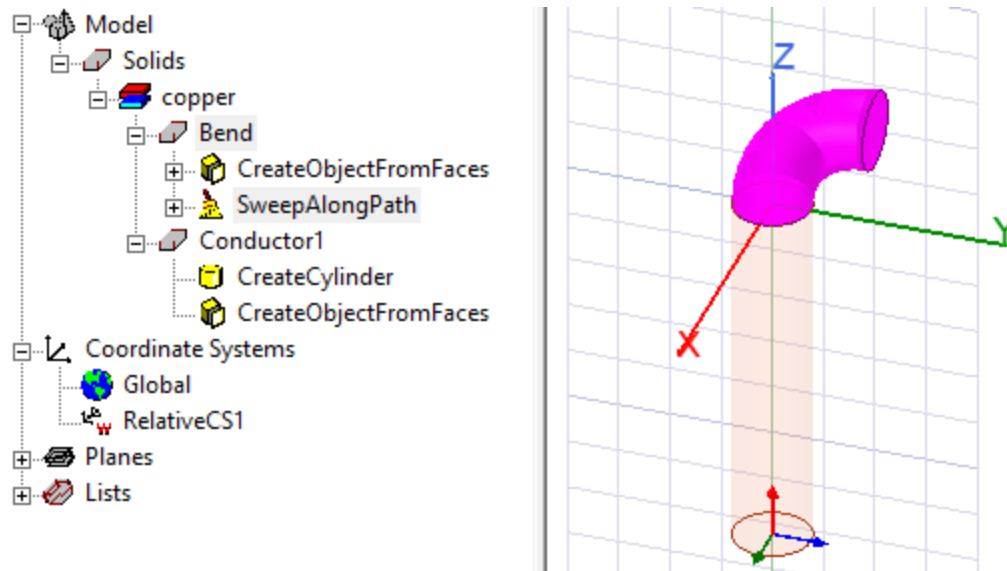

Figure 3-11: Swept Bend

Note:

Because the object *Bend* was derived from a face of *Conductor1*, a copper part, the material *copper* has already been assigned to it.

Create Conductor 2

Draw a cylinder starting at the exposed end of the *Bend* to create *Conductor2*.

1. Click in the Modeler window's background area to clear the current selection.
2. Verify that **RelativeCS1** (under Coordinate Systems in the History Tree) is still active.

Note:

A “w” icon indicates the current working coordinate system.

3. On the **Draw** ribbon tab, select **XZ** from the **Drawing plane** drop-down menu:

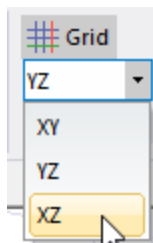



Figure 3-12: Selecting XZ Drawing Plane

4. On the **Draw** ribbon tab, click  **Draw cylinder**.
 - a. Click at the center point of the exposed face of the *Bend*. The cursor changes to a sphere at the center point:

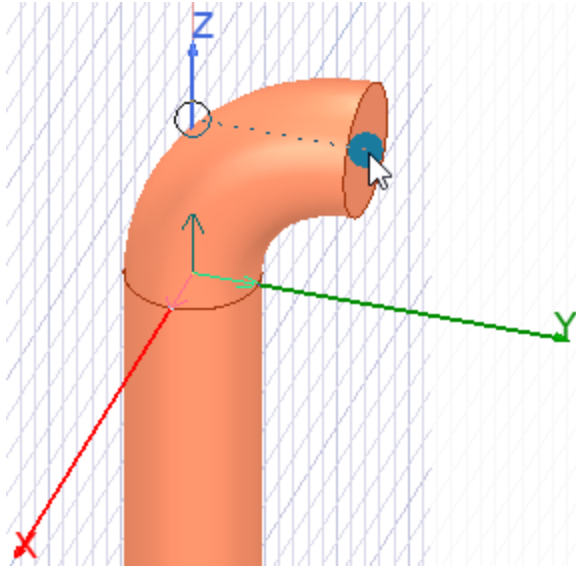

Figure 3-13: First Point for Defining *Conductor2*

- b. Click on a quadrant point along the circular edge of the Bend's exposed face. The cursor changes to a quarter-circle at a quadrant snapping point:

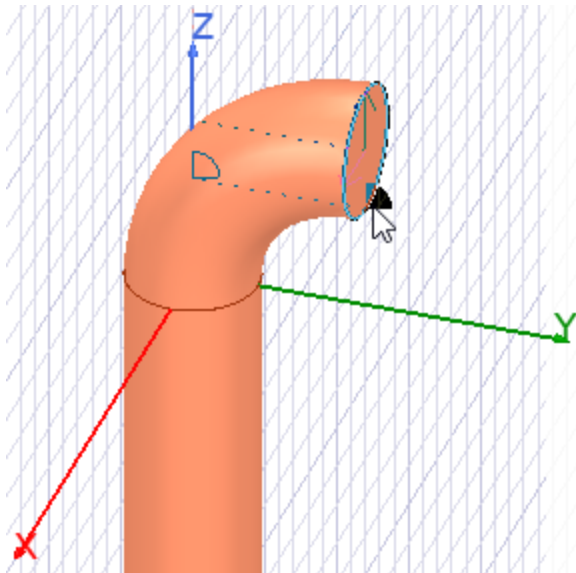

Figure 3-14: Second Point for Defining *Conductor2*

5. Move the mouse in the +Y direction of *RelativeCS1* and click to form a cylinder of any length.

The *Properties* dialog box appears.

6. On the **Command** tab of the *Properties* dialog box, change the cylinder **Height** to **0.3 cm** and verify that the remaining values are in agreement with the following figure:

| Command | | Attribute | | |
|--------------------|----------------|-----------|---------------------|--|
| Name | Value | Unit | Evaluated Value | |
| Command | CreateCylinder | | | |
| Coordinate System | RelativeCS1 | | | |
| Center Position | 0 ,0.4 ,0.4 | cm | 0cm , 0.4cm , 0.4cm | |
| Axis | Y | | | |
| Radius | 0.152 | cm | 0.152cm | |
| Height | 0.3 | cm | 0.3cm | |
| Number of Segments | 0 | | 0 | |

Figure 3-15: Conductor2 Properties – Command Tab

7. On the **Attribute** tab of the *Properties* dialog box, change the **Name** to **Conductor2**, select the **Material Appearance** option, and click **OK**.
8. Click in the Modeler window's background area to clear the current selection.

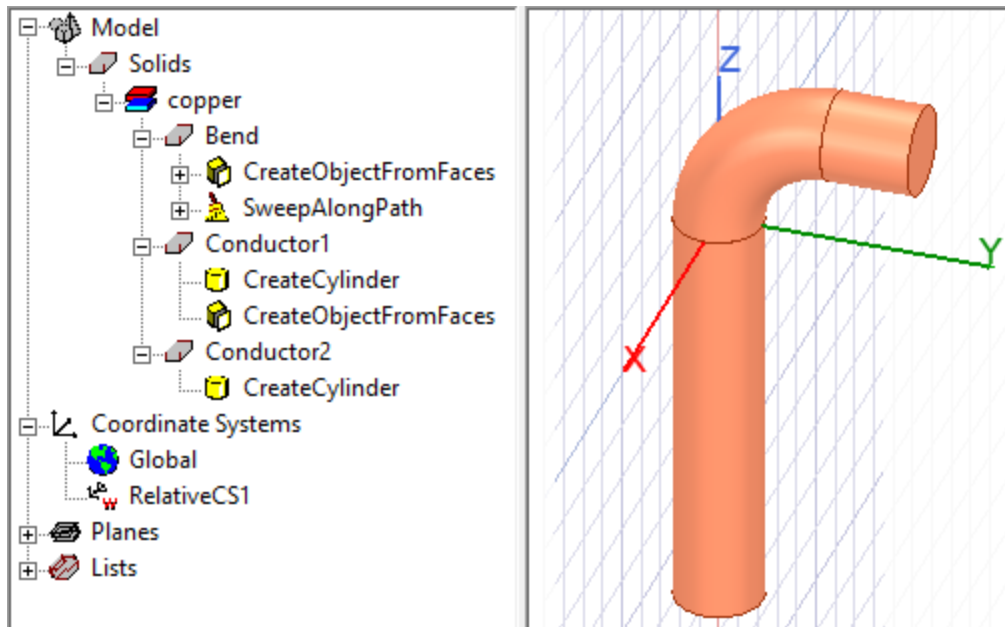



Figure 3-16: Conductor2 Created

Create Second Offset Coordinate System

Create the second offset coordinate system to facilitate creation of *Conductor3*, *Female*, and *FemaleBend* objects.

1. On the **Draw** ribbon tab, click  **Relative CS > Offset**.
2. Click the center point of the exposed face of *Conductor2*. The cursor becomes a sphere to indicate the center point of the face.

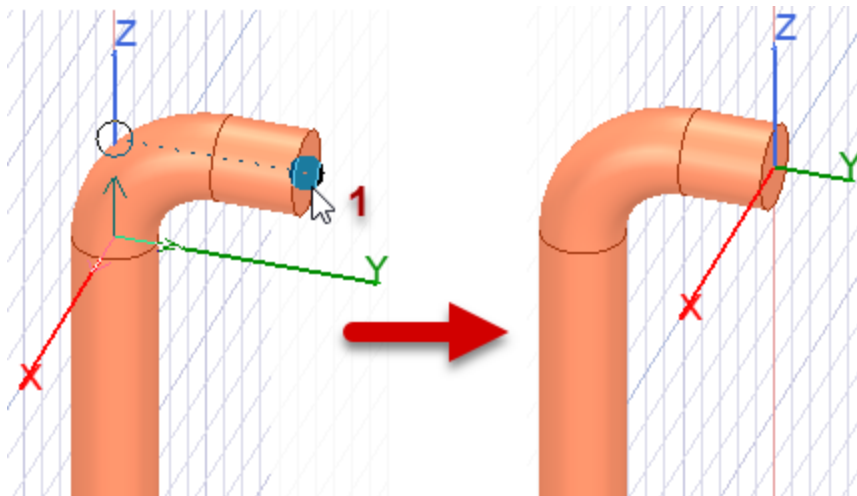



Figure 3-17: Defining Second Offset Coordinate System

The grid and axes move to the new location with the origin at the clicked center point. Also, *RelativeCS2* is added to the History Tree, and it is now the working coordinate system.

Create Conductor 3

1. With **RelativeCS2** as the working coordinate system, on the **Draw** ribbon tab, click  **Draw cylinder**.
2. Click the center point of the exposed face of *Conductor2* as the starting location for the next cylinder.
 - a. Move the mouse along the grid and click to set a radius of any size for the cylinder base.
 - b. Move in the +Y direction and click once more to create a cylinder of any length.

The *Properties* dialog box appears.

3. On the **Command** tab of the *Properties* dialog box, edit the values as in shown in the following figure.

| Command | | Attribute | | |
|-------------------|----------------|-----------|-----------------|--|
| Name | Value | Unit | Evaluated Value | |
| Command | CreateCylinder | | | |
| Coordinate Sys... | RelativeCS3 | | | |
| Center Position | 0,0,0 | cm | 0cm, 0cm, 0cm | |
| Axis | Y | | | |
| Radius | 0.225 | cm | 0.225cm | |
| Height | 1.3 | cm | 1.3cm | |
| Number of Seg... | 0 | | 0 | |

Figure 3-18: *Conductor3* Properties Dialog Box – Command Tab

- On the **Attribute** tab, change the **Name** to **Conductor3**.
- Select the **Material Appearance** option and click **OK**.
- Click in the background to clear the current selection.

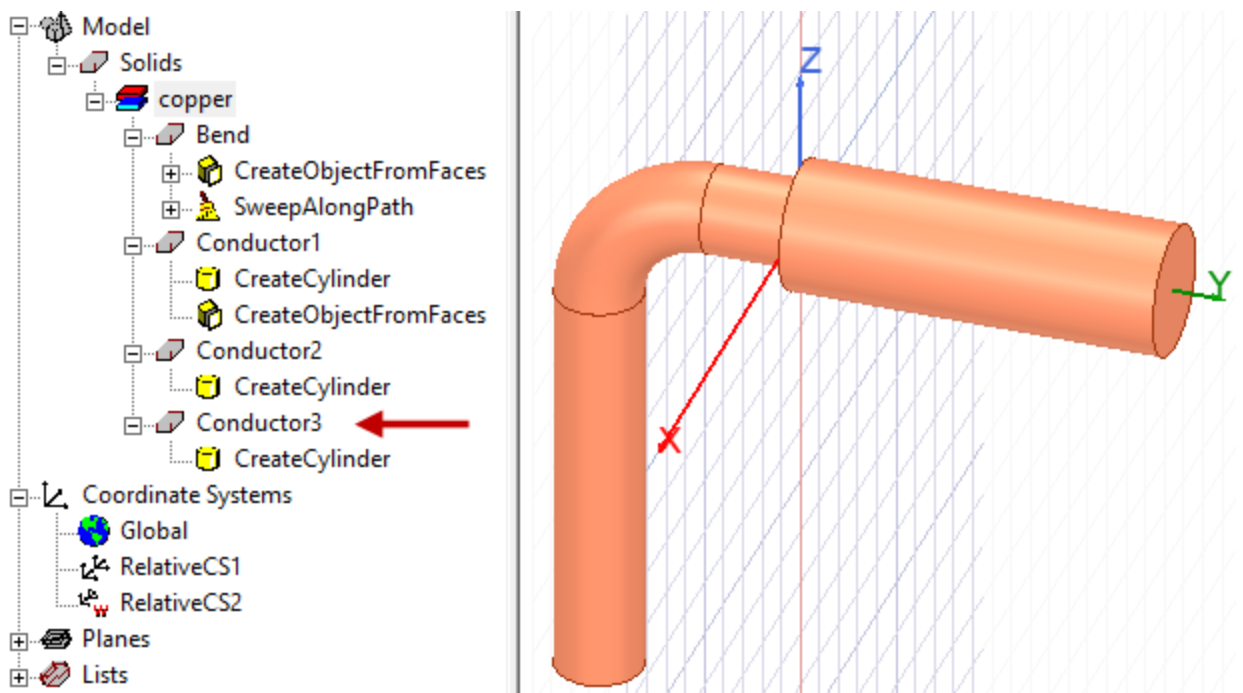

Figure 3-19: *Conductor3* Created

Unite Conductors 1, 2, 3, and Bend

- Press **Ctrl+A** to select all objects in the model.
- On the **Draw** ribbon tab, click **Unite**.
- In the docked Properties window, change the **Name** to **Conductor** and press **Enter**.

There is now a single part, *Conductor*, listed under *copper* in the History Tree.

4. Click in the background area to clear the current selection.

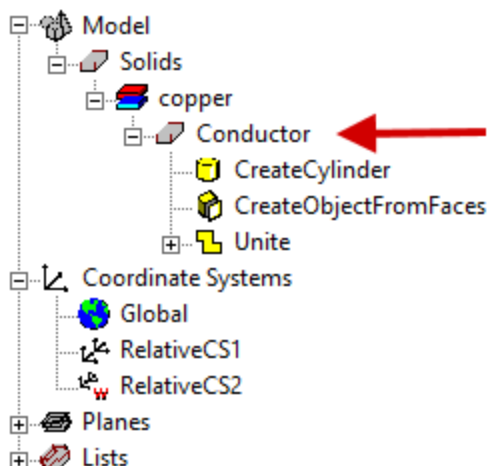

Figure 3-20: United *Conductor* Part in the History Tree

In the topics that follow, you will create and unite the *vacuum* objects, which represent the space around the conductor inside the coax connector envelope.

Create the Female End

Before creating any of the vacuum objects, you will choose *vacuum* as the default material. The color and transparency level defined in the materials library for *vacuum* makes it a bit difficult to see. So, you can adjust the appearance for vacuum parts within the current project when choosing the material, as outlined below.

Specify the Default Material and Its Appearance:

1. On the **Draw** ribbon tab, choose **Select** from the **Default material** drop-down menu.

The *Select Definition* dialog box appears.

In the next step, you will select the material *vacuum*. Even though this material is already listed in the *Default material* drop-down menu, you are opening the *Select Definition* dialog box to alter the material appearance attributes for this project.

2. Type **vac** in the **Search** text box, and **vacuum** becomes highlighted in the materials list.

Ensure that the selected *vacuum* material is the one indicating **Project** in the **Location** column. A Project definition already exists for this material because it is initially the default material for HFSS designs. You cannot alter the properties of the *System* material, but you can edit project materials.

3. Click **View/Edit Materials**. Then, in the dialog box that appears, make the following changes:

- a. Under *Material Appearance*, ensure that the **Use Material Appearance** option is selected.
- b. Change the **Color** to a somewhat darker shade of gray (**Red: 192, Green: 192, and Blue: 192**).
- c. Change the **Transparency** to **0.6**.
- d. Click **OK** to close the *View / Edit Material* dialog box, but leave the *Select Definition* dialog box open.

Note:

This method of redefining the appearance is more efficient than defining the material color and transparency separately for each new vacuum part you create. It is a one-time change, and all future vacuum parts added to the project will have the desired appearance attributes.

- e. Click **OK** to close the *Select Definition* dialog box.

Create the Female End Object:

4. Ensure that **RelativeCS2** under *Coordinate Systems* in the History Tree, is the current working coordinate system.
5. On the **Draw** ribbon tab, click  **Draw cylinder**.
6. Draw a cylinder of any size and location.

After the third click, the *Properties* dialog box appears.

7. On the **Command** tab of the *Properties* dialog box, edit the values as shown in the following figure:

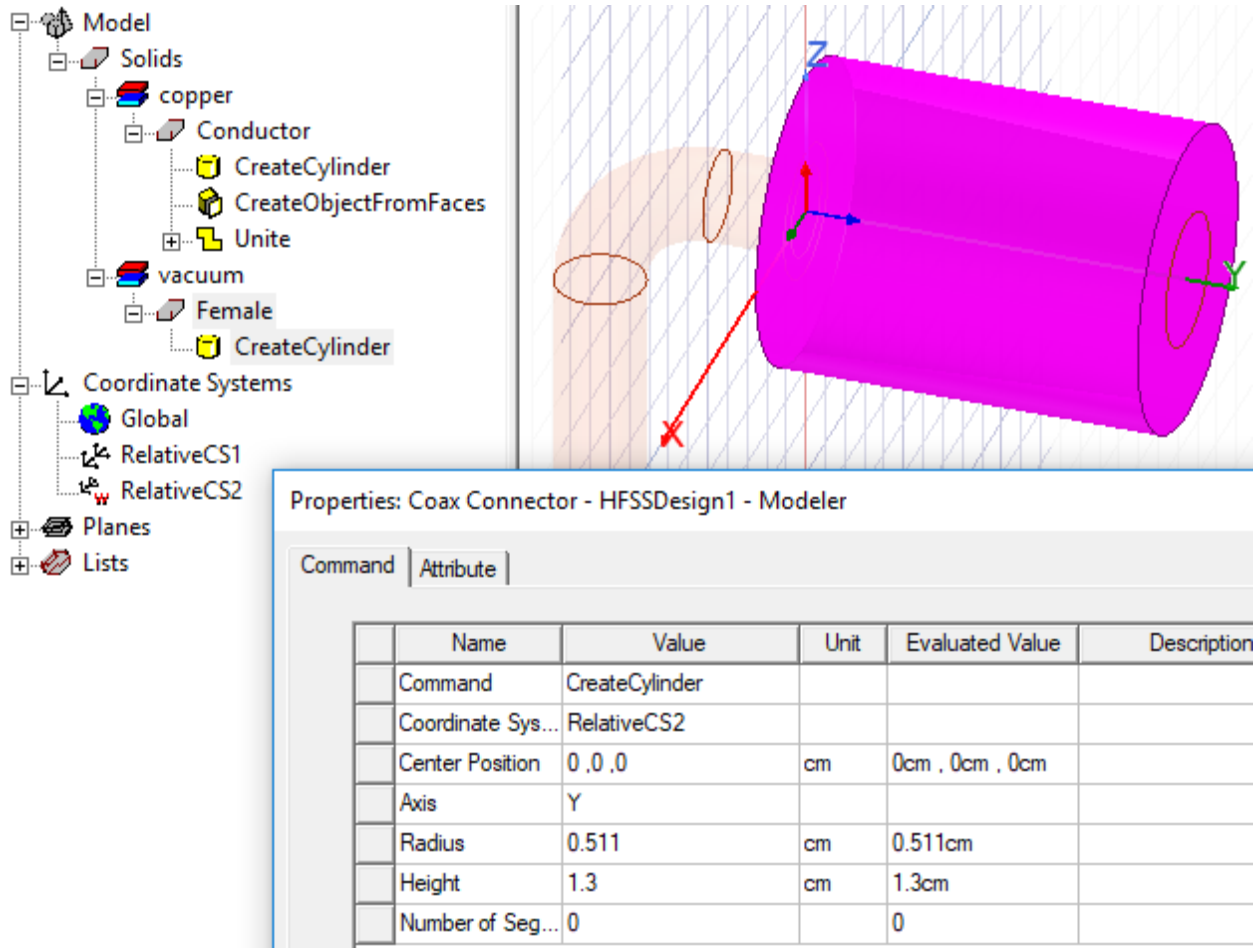
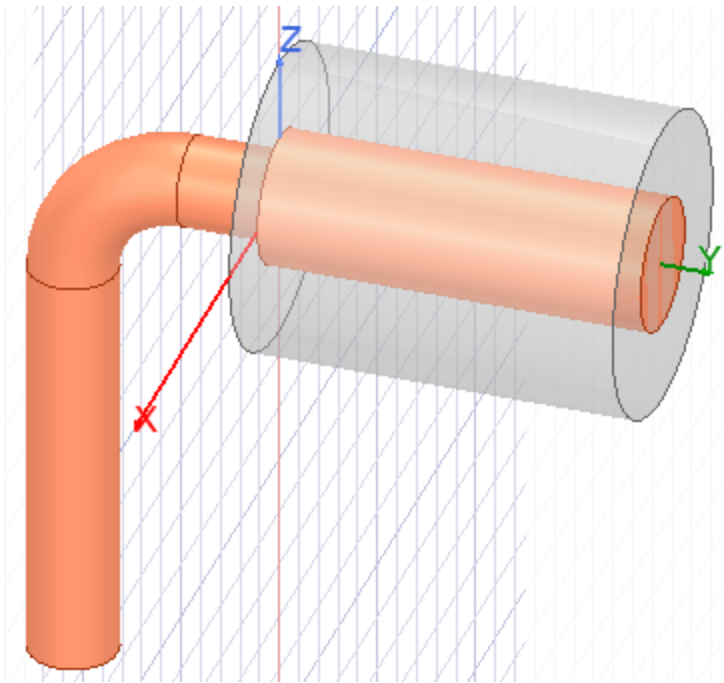

Figure 3-21: Female End Properties – Command Tab

Keep the dialog box open.

8. On the **Attribute** tab, change the **Name** of the object to **Female**.
9. Select the **Material Appearance** option and click **OK**.
10. Click in the background area to deselect the object.



Create the Female Bend

You will now create the female bend.

1. **Draw** another **Cylinder** of any size and location and edit the values in the **Command** tab of the *Properties* window, as shown in the following figure:

| Command | | Attribute | | |
|---------|-------------------|----------------|------|-----------------|
| | Name | Value | Unit | Evaluated Value |
| | Command | CreateCylinder | | |
| | Coordinate Sys... | RelativeCS3 | | |
| | Center Position | 0 , 0 , 0 | cm | 0cm , 0cm , 0cm |
| | Axis | Y | | |
| | Radius | 0.351 | cm | 0.351cm |
| | Height | -1.236 | cm | -1.236cm |
| | Number of Seg... | 0 | | 0 |

Figure 3-22: Female Bend Properties – Command Tab

2. On the **Attribute** tab, change the **Name** to **FemaleBend**, select the **Material Appearance** option, and click **OK**.
3. Click in the background area to clear the current selection.

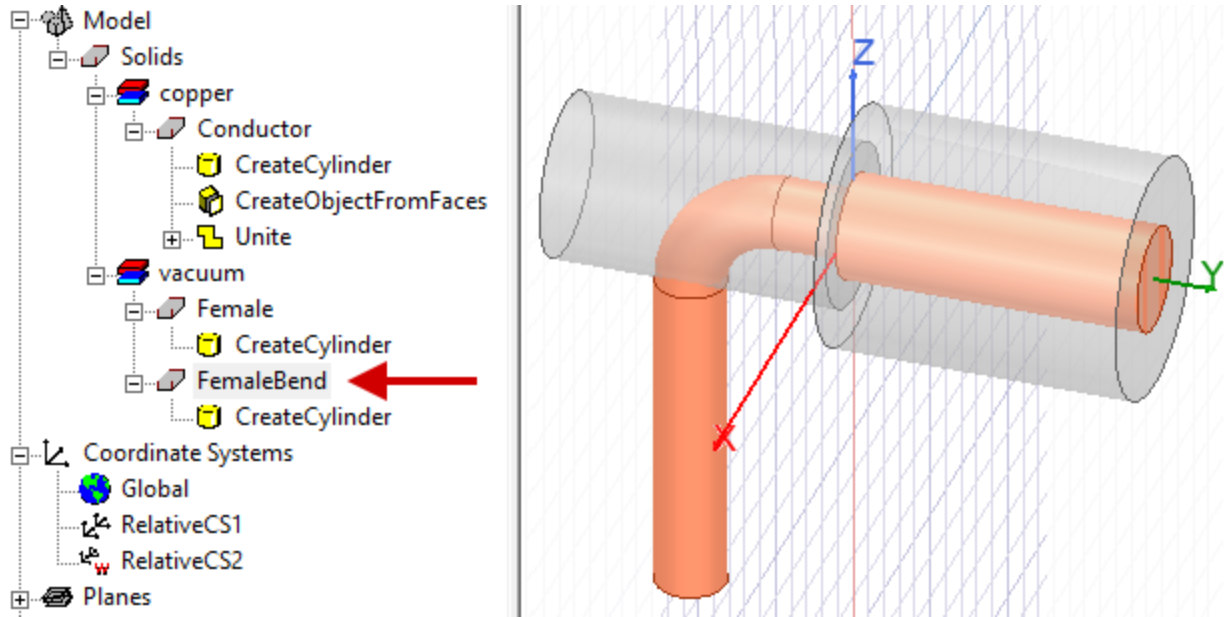
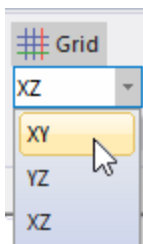

Figure 3-23: Female Bend Object Created

Create the Male End

For the next two objects you create, use the *XY* plane of the *Global* coordinate system.

1. Select **Global** under **Coordinate Systems** in the History Tree to set it as the working coordinate system.
2. On the **Draw** ribbon tab, select **XY** from the **Drawing plane** drop-down menu .



3. **Draw** a random **Cylinder** and edit the values in the **Command** tab of the *Properties* dialog box, as shown in the following figure:

| Command | | Attribute | | |
|---------|-------------------|----------------|------|-----------------|
| | Name | Value | Unit | Evaluated Value |
| | Command | CreateCylinder | | |
| | Coordinate Sys... | Global | | |
| | Center Position | 0,0,0 | cm | 0cm, 0cm, 0cm |
| | Axis | Z | | |
| | Radius | 0.351 | cm | 0.351cm |
| | Height | 2.348 | cm | 2.348cm |
| | Number of Seg... | 0 | | 0 |

Figure 3-24: Male Properties – Command Tab

- On the **Attribute** tab, change the Name to **Male**, select the **Material Appearance** option, and click **OK**.
- Clear the current selection. Your model should look like the image below:

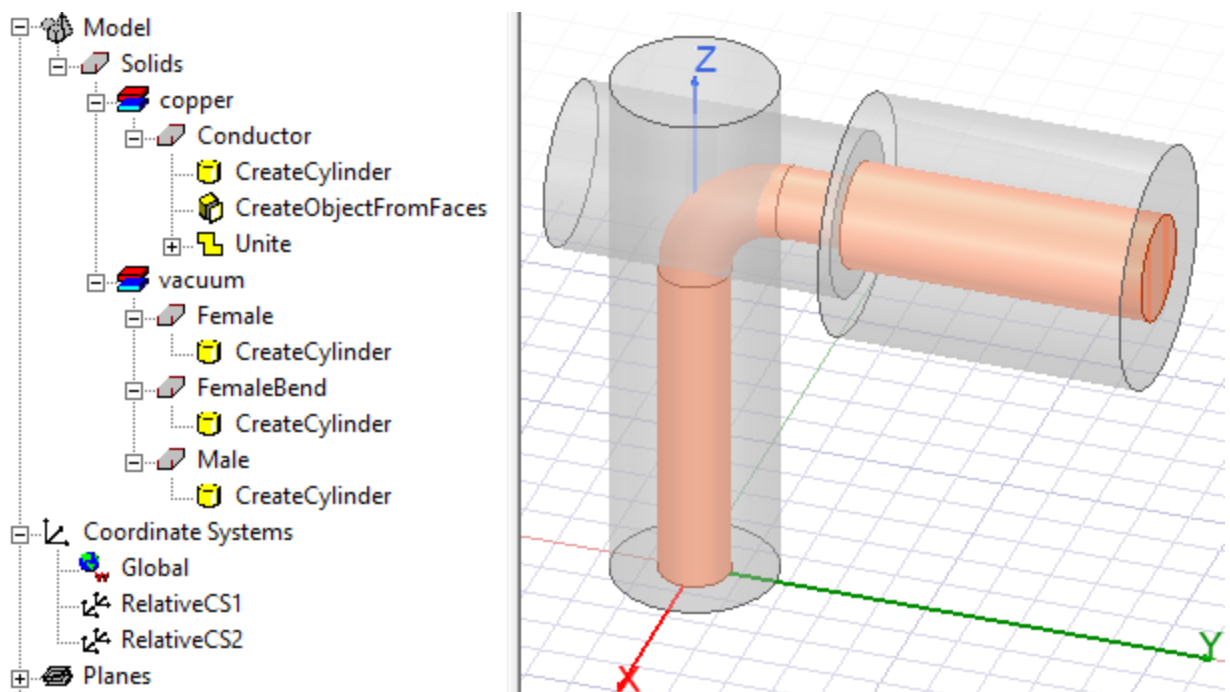

Figure 3-25: Male End Created

Unite Female, FemaleBend, and Male

- On the **Draw** ribbon tab, ensure that the current **Select** mode is **Object** and then click **Select By Name**.

The *Select Object* dialog box appears.

- From the dialog box, select **Female**, **FemaleBend**, and **Male**.

Note:

Make these selections in the above specified order and then click **OK**.

- On the **Draw** ribbon tab, click  **Unite**.

All the *vacuum* objects are combined into a single part named *Female*. The first item selected determines the name of the united part.

- Clear the current selection.

Notice that oval edges appear at the intersection of the vertical and horizontal cylindrical surfaces after they're united.

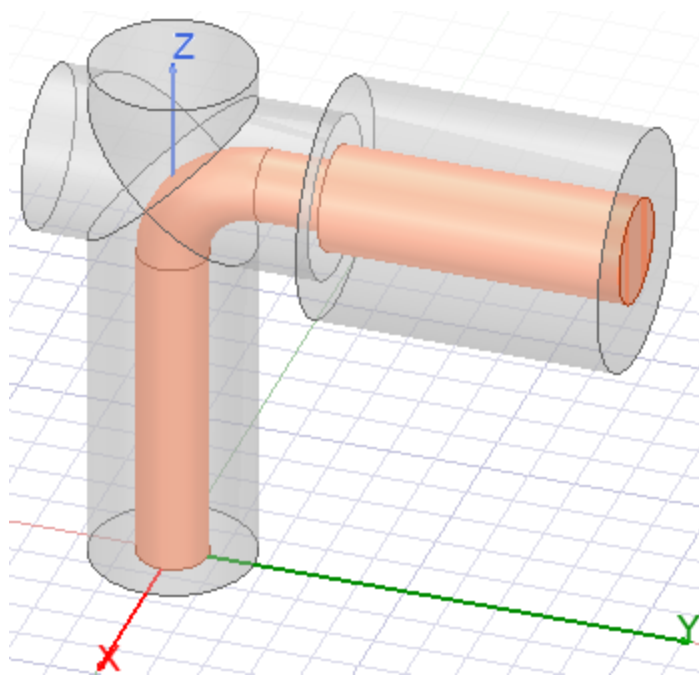

Figure 3-26: Intersection Appearance after Cylindrical Parts are United

Create the Ring

To create the ring, draw a cylinder freehand and define a new material, as follows:

- Draw** a random **Cylinder** and edit its values in the **Command** tab of the *Properties* dialog box, as shown in the following figure:

| Command | | Attribute | | |
|---------|-------------------|----------------|------|--------------------|
| | Name | Value | Unit | Evaluated Value |
| | Command | CreateCylinder | | |
| | Coordinate Sys... | Global | | |
| | Center Position | 0 ,0 ,0.736 | cm | 0cm , 0cm , 0.7... |
| | Axis | Z | | |
| | Radius | 0.511 | cm | 0.511cm |
| | Height | 0.236 | cm | 0.236cm |
| | Number of Seg... | 0 | | 0 |

Figure 3-27: Ring Properties – Command Tab

Leave the dialog box open.

2. On the **Attribute** tab of the *Properties* dialog box, change the **Name** to **Ring**.
3. Also, on the **Attribute** tab, select **Edit** from the **Material** drop-down menu.
4. In the *Select Definition* dialog box, click **Add Material** and make the following changes:
 - a. Type **My_Ring** into the **Material Name** text box.
 - b. Set the value of the **Relative Permittivity** at **3**.
 - c. Select the **Use Material Appearance** option.
 - d. Choose a medium blue color (**Red: 0, Green: 128, and Blue: 255**).
 - e. Set the **Transparency** at **0.4**.
5. Click **OK** twice to close both the *View / Edit Material* and *Select Definition* dialog boxes.
6. In the **Attribute** tab of the *Properties* dialog box, select the **Material Appearance** option and click **OK**.

Do not clear the selection yet.

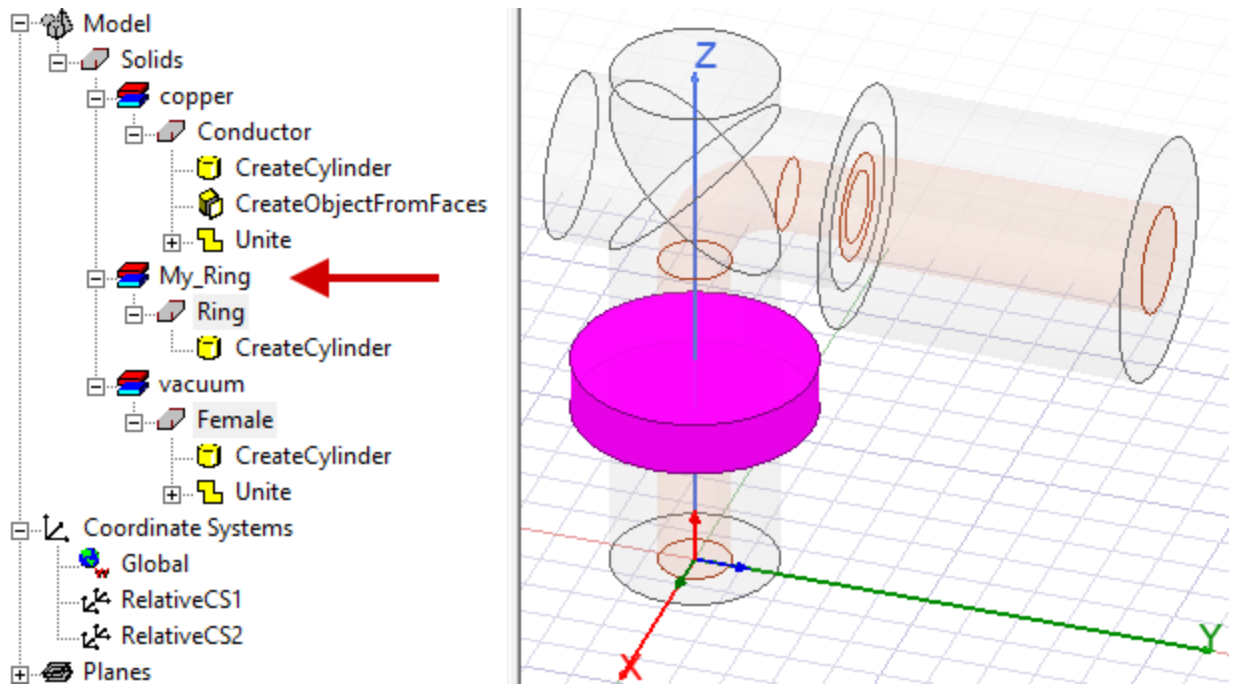

Figure 3-28: Ring Object Created

Complete the Ring

To complete the Ring, you will use the Female part as a cutting tool to subtract out the inside diameter portion of the Ring.

1. Select **Ring** in the History Tree
2. Hold down **Ctrl** and also select **Female** in the History Tree.
3. On the **Draw** ribbon tab, click **Subtract**.

The *Subtract* dialog box appears.

4. Ensure the settings are as shown in the following figure and click **OK**.

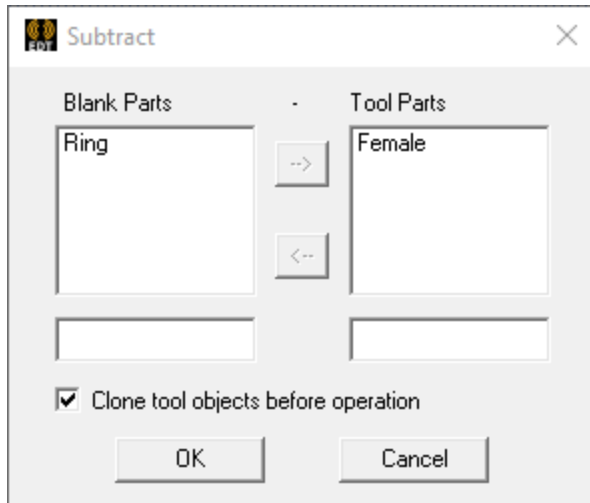

Figure 3-29: Subtract Dialog Box.

Note:

The *Ring* is complete and is no longer a disk shape. It is placed around the OD of the *Female* (vacuum) part at the male end of the connector.

5. Clear the current selection. Your model should look like the following figure:

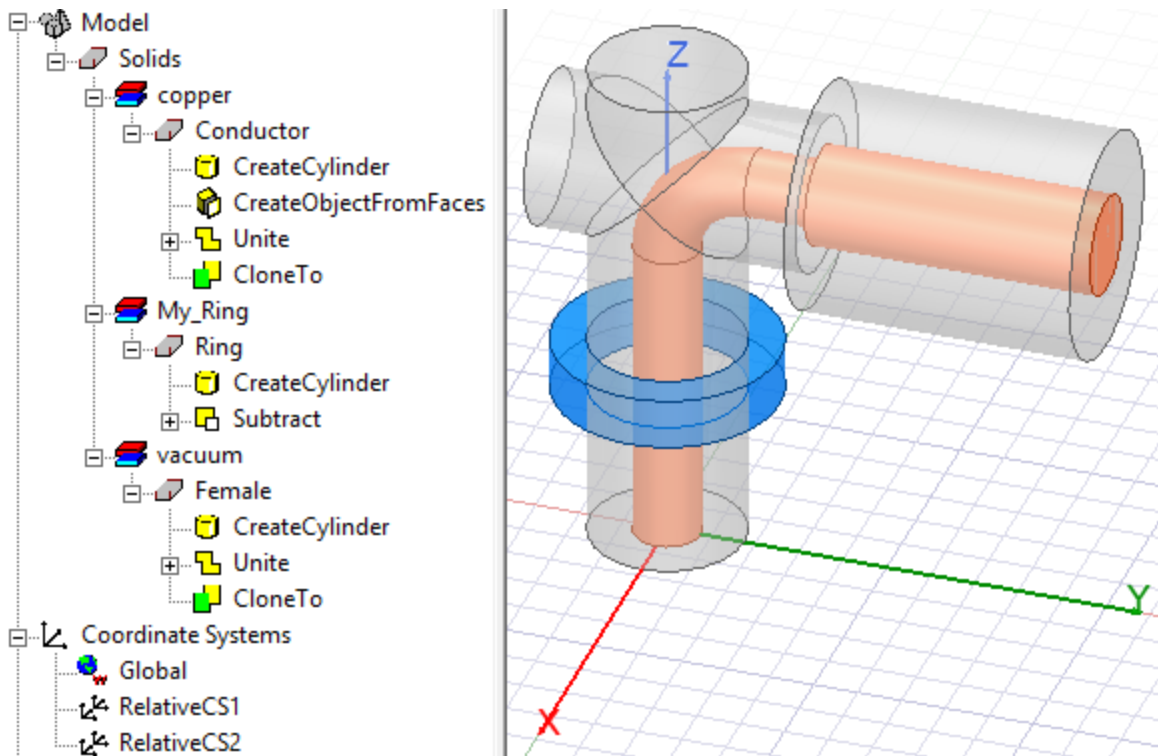

Figure 3-30: The Completed Ring

Create the Male Teflon

You will be creating two Teflon parts, so before doing so, you can define a new default material, *My_Teflon*, complete with appearance data. This step eliminates the need of setting the material and its appearance twice. Then, to create the *MaleTeflon* part, draw a random cylinder and edit its size and location.

Specify the Default Material and Its Appearance:

1. On the **Draw** ribbon tab, choose **Select** from the **Default material** drop-down menu.

The *Select Definition* dialog box appears.

2. Click **Add Material**. Then, in the *View / Edit Material* dialog box that appears, make the following changes:
 - a. Type **My_Teflon** in the **Material Name** text box.
 - b. Change the **Relative Permittivity** value to **2.1**.
 - c. Under *Material Appearance*, ensure that the **Use Material Appearance** option is selected.
 - d. Change the **Color** to a bright yellow (**Red: 255, Green: 255, and Blue: 128**).
 - e. Change the **Transparency** to **0.7**.
 - f. Click **OK** twice, to close the *View / Edit Material* and the *Select Definition* dialog boxes.

Create the Male Teflon Part:

3. **Draw** a random **Cylinder** and edit the values on the **Command** tab of the *Properties* dialog box, as shown in the following figure:

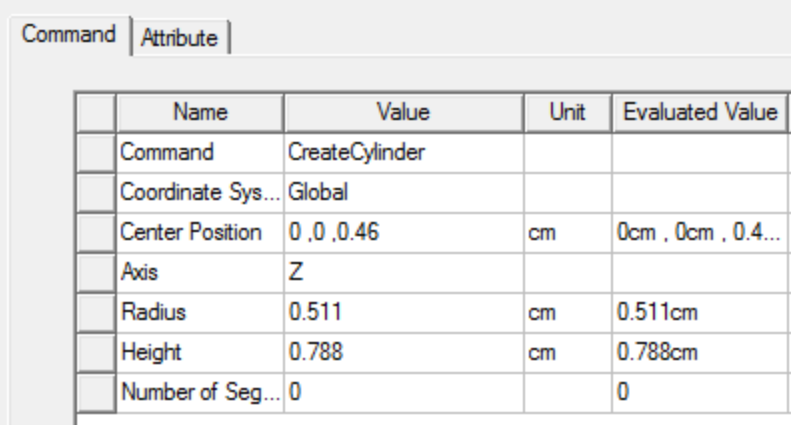

| | Name | Value | Unit | Evaluated Value |
|-------------------|-------------------|----------------|------|--------------------|
| Command | Command | CreateCylinder | | |
| Coordinate Sys... | Coordinate Sys... | Global | | |
| Center Position | Center Position | 0 ,0 ,0.46 | cm | 0cm , 0cm , 0.4... |
| Axis | Axis | Z | | |
| Radius | Radius | 0.511 | cm | 0.511cm |
| Height | Height | 0.788 | cm | 0.788cm |
| Number of Seg... | Number of Seg... | 0 | | 0 |

Figure 3-31: Male Teflon Properties – Command Tab

4. On the **Attribute** tab change the **Name** to **MaleTeflon**.
5. Select the **Material Appearance** option and click **OK**.

Subtract the Ring from the Male Teflon Part:

Optionally, subtract the *Ring* from the *MaleTeflon* part so that the model reflects the actual construction of the coax connector (with no overlapping parts). If you do *not* perform this operation, the solver will automatically use the *Ring* material properties where the two parts overlap, since the *Ring* volume is completely contained within the *MaleTeflon* volume. So, this operation will not change the analysis results. However, it's a good practice to model the assembly as it is actually built. This practice also avoids potential problems when objects partially intersect. In such cases, the solver may not correctly determine which material properties to use and which to ignore.

6. In the History Tree, select **MaleTeflon**.
7. Hold down Ctrl and also select **Ring**.
8. In the **Draw** ribbon tab, click  **Subtract**.
9. Ensure that the *Subtract* dialog box settings are as pictured below and click **OK**.

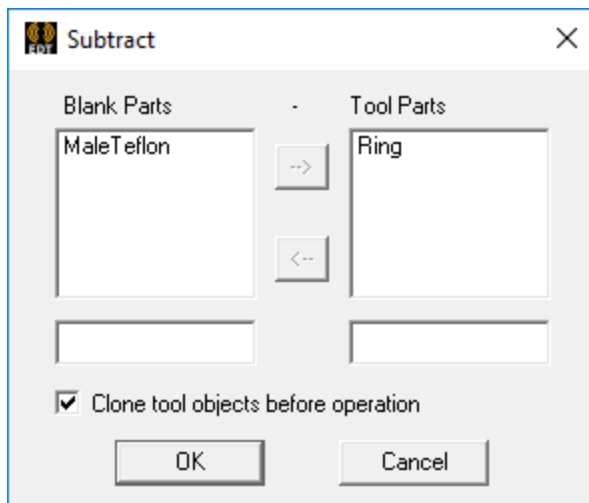

Figure 3-32: Subtract Dialog Box

10. Clear the current selection.

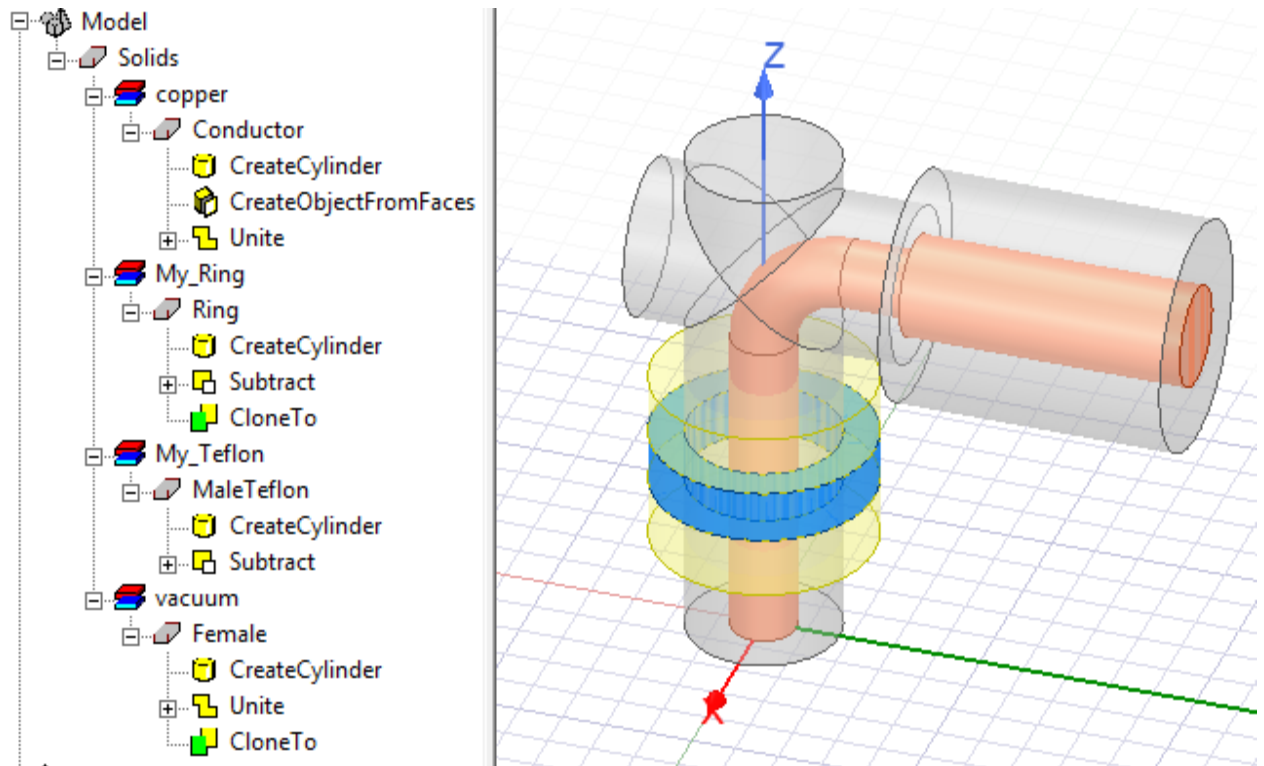

Figure 3-33: Male Teflon Created

Create the Female Teflon

Create one more cylinder and place it inside the structure that you have drawn so far, as follows.

1. **Draw** a random **Cylinder** and edit the values in the **Command** tab of the *Properties* dialog box as shown below, including the **Coordinate System** and **Axis** fields.

| Command | | Attribute | | |
|--------------------|----------------|-----------|-----------------|--|
| Name | Value | Unit | Evaluated Value | |
| Command | CreateCylinder | | | |
| Coordinate System | RelativeCS2 | | | |
| Center Position | 0,0,0 | cm | 0cm, 0cm, 0cm | |
| Axis | Y | | | |
| Radius | 0.511 | cm | 0.511cm | |
| Height | -0.236 | cm | -0.236cm | |
| Number of Segments | 0 | | 0 | |

Figure 3-34: Female Teflon Properties – Command Tab

2. On the **Attribute** tab change the Name to **FemaleTeflon**, select the **Material Appearance** option, and click **OK**.

3. Clear the current selection.

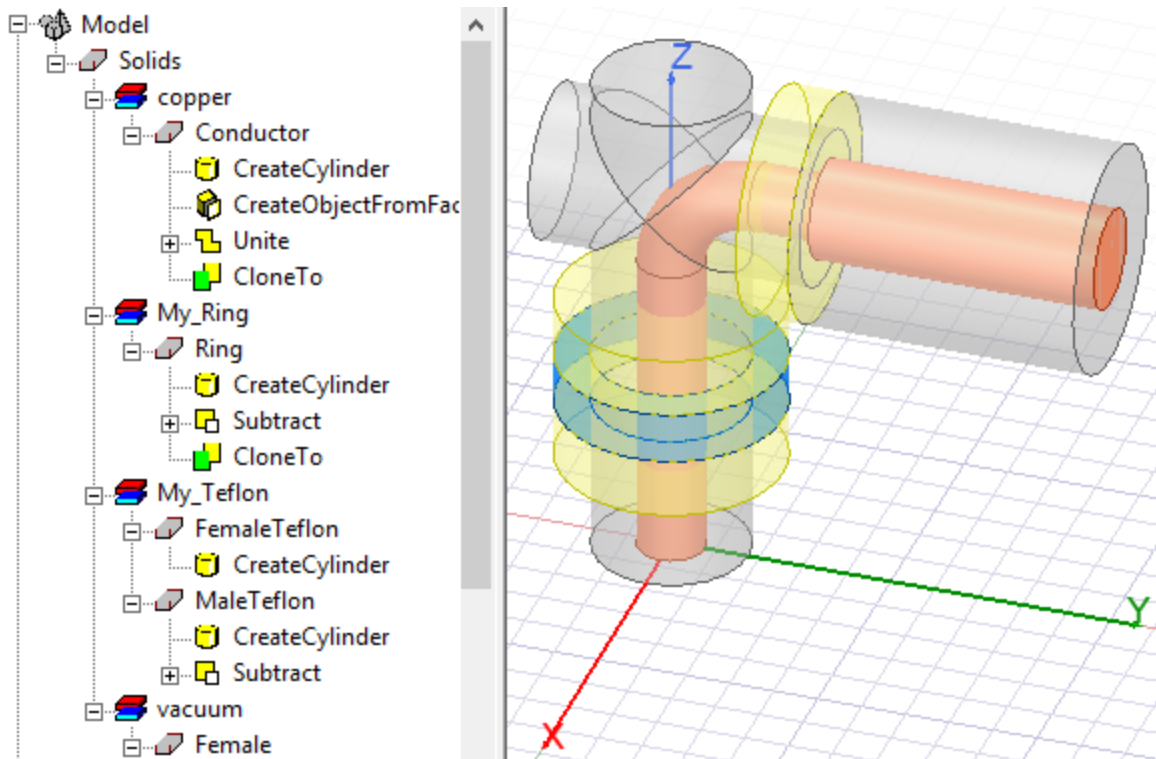

Figure 3-35: The Female Teflon Created

Complete the Vacuum Object

Complete the vacuum object.

1. Press **O** to enter the object selection mode and, on the **Draw** ribbon tab, click **Select By Name**.

The *Select Object* dialog box appears.

2. Select the objects **Female**, **FemaleTeflon**, and **MaleTeflon** (in that specific order) and click **OK**.
3. Click **Subtract** on the Draw ribbon tab.

The *Subtract* dialog box appears.

4. Ensure that the settings in the *Subtract* dialog box are as pictured below and click **OK**.

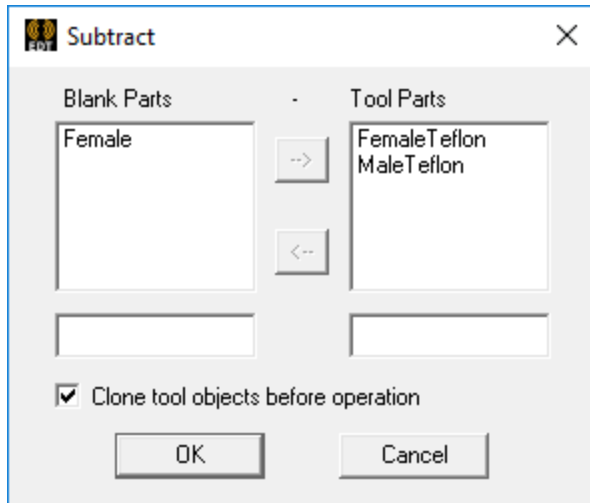

Figure 3-36: Subtract Dialog Box

The vacuum part, *Female*, is cut away where it was overlapped by the *FemaleTeflon* and *MaleTeflon* parts.

Complete the Model

Complete creating the model by subtracting the portions of the *Female*, *FemaleTeflon*, and *MaleTeflon* parts where they are overlapped by the *Conductor*.

1. From the History Tree, select **Female**.
2. Hold down **Ctrl** and also select **FemaleTeflon**, **MaleTeflon**, and **Conductor** from the History tree.
3. On the **Draw** ribbon tab, click  **Subtract**.

The *Subtract* dialog box appears.

4. In the *Tool Parts* list, select **FemaleTeflon** and **MaleTeflon**. Then, click the left-pointing arrow () to move these two parts to the *Blank Parts* list.
5. Select the **Clone tool objects before operation** option.

The *Subtract* dialog box should be identical to the following figure:

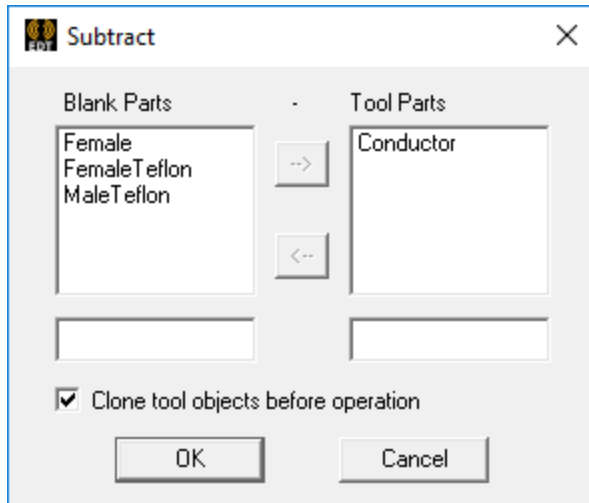

Figure 3-37: Subtract Dialog Box

6. Click **OK** to complete the operation and then clear the selection.

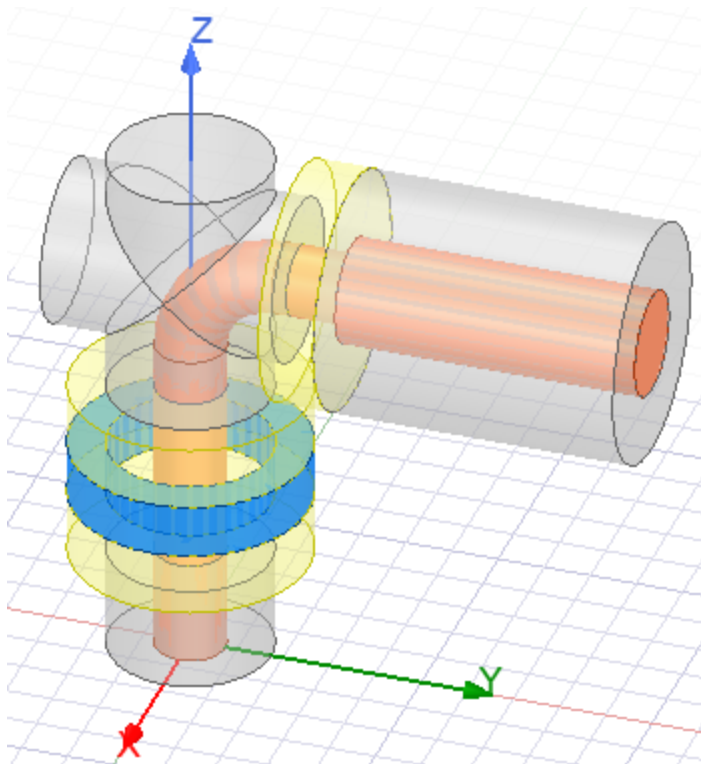

Figure 3-38: Model Geometry Completed

You are now finished with the model construction. You will next assign excitations and set up the analysis.

Assign Excitation 1

For this model we will use wave ports to excite both ends of the coax connector. This section describes how to assign the first excitation.

1. Press **F** to enter the face selection mode.
2. On the **Draw** ribbon tab, click **Orient > Bottom (+Z)**.

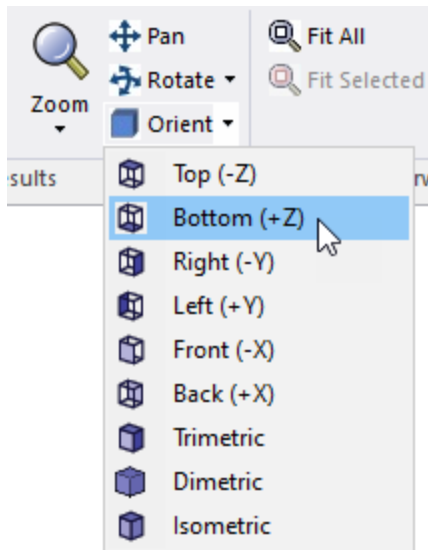

3. Press **Ctrl+D**, if needed, to fit the view.
4. Select the bottom face, as indicated below:

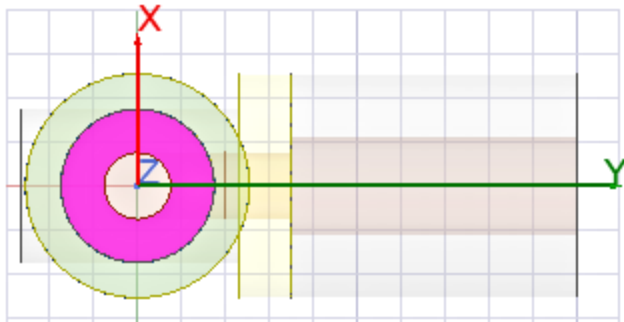

Figure 3-39: The Bottom Face Selected

5. In the Modeler window, right-click, and choose **Assign Excitation > Port > Terminal Wave Port** from the shortcut menu.

The *Reference Conductors for Terminals* dialog box appears.

6. Set the **Port Name** to **P1**, select the **Use port object name** option, and click **OK**.

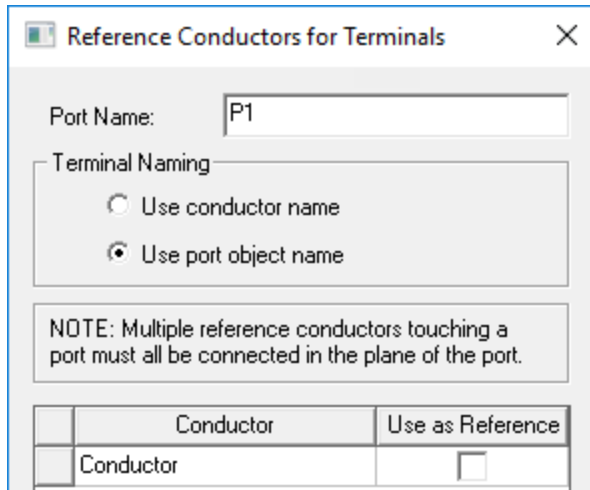

Figure 3-40: Reference Conductors for Terminals Dialog Box

The excitation gets assigned and **P1** and its associated terminal appear in the Project Manager.

- Under *Excitations* > *P1* in the Project Manager, select the terminal **Female_T1**.

Note:

You may see a different terminal name under *P1* if you did not select the vacuum parts in exactly the prescribed order when uniting them in an earlier procedure.

- In the docked *Properties* window, change the terminal Name to **P1_T1** and press **Enter**.
- Alternately, select **P1** and **P1_T1** to see them visualized on the model.

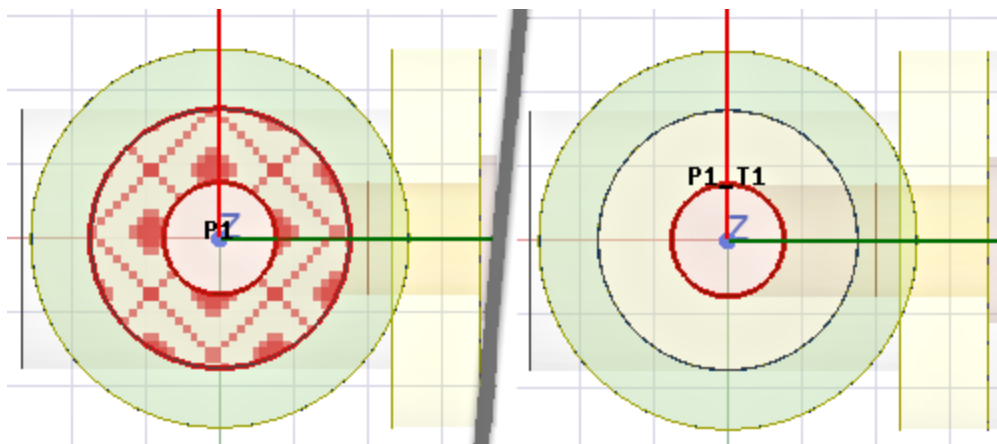
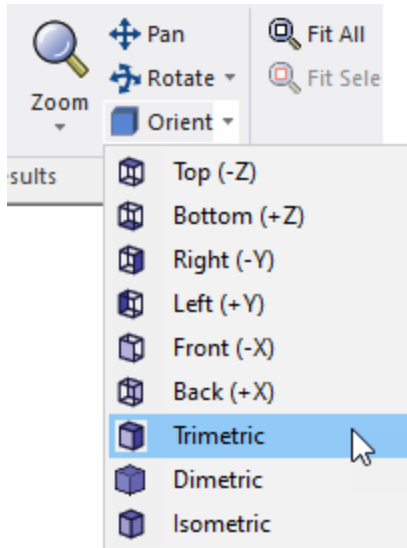

Figure 3-41: The Port *P1* and Terminal *Female_T1* Visualization

Assign Excitation 2

To assign the second excitation, do the following:

1. On the **Draw** ribbon tab, click **Orient > Trimetric** to restore the default orientation of the model view.



2. Select the end (+Y) face of the *Female* part of the model, as shown below:

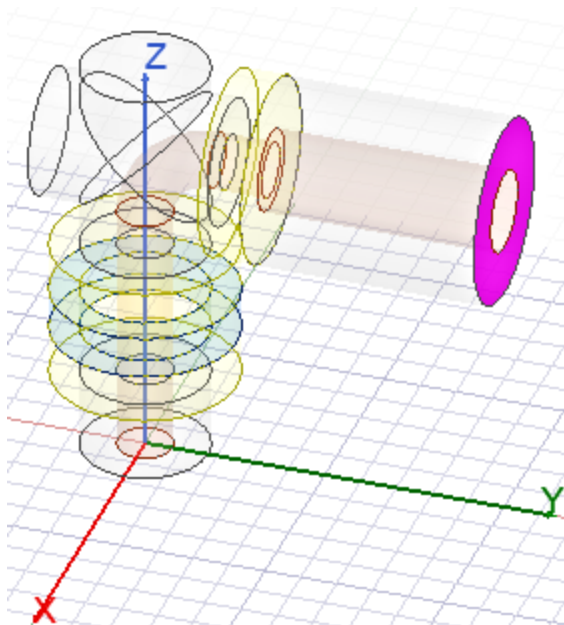

Figure 3-42: Second Excitation Face

3. Right-click and choose **Assign Excitations > Port > Terminal Wave Port**.

The *Reference Conductors for Terminals* dialog box appears.

4. Set the **Port Name** to **P2**, select the **Use port object name** option, and click **OK**.

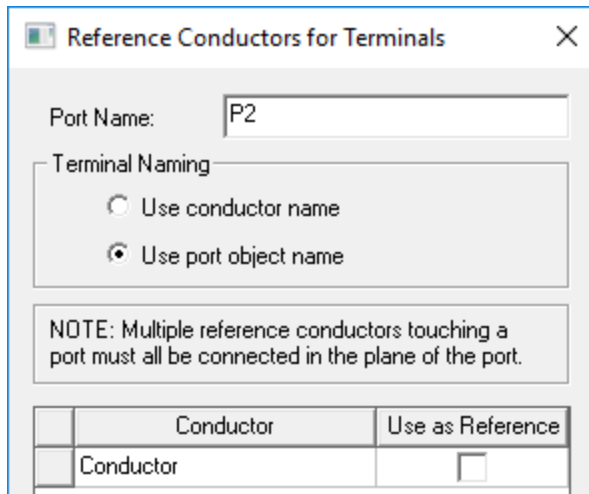
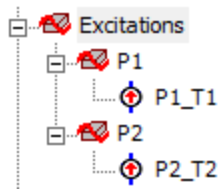

Figure 3-43: Reference Conductors for Terminals Dialog Box

The new wave port and terminal definitions appear in the Project Manager.

5. Under *Excitations* > *P2* in the Project Manager, select the terminal **Female_T2**.
6. In the docked *Properties* window, change the terminal Name to **P2_T2** and press **Enter**.



Boundary Display (Optional)

The Boundary Display (Solver View) provides a snapshot of all boundaries in the model, including ports and outer faces of model objects. It can be useful for diagnosing problems with design setups.

1. On the **View** ribbon tab, click  **Hide/Show overlaid visualization in the active view**.

Note:

The *Active View Visibility* dialog box appears.

2. On the **3D Modeler** tab, you can control **Visibility** of any of the objects comprising the model.

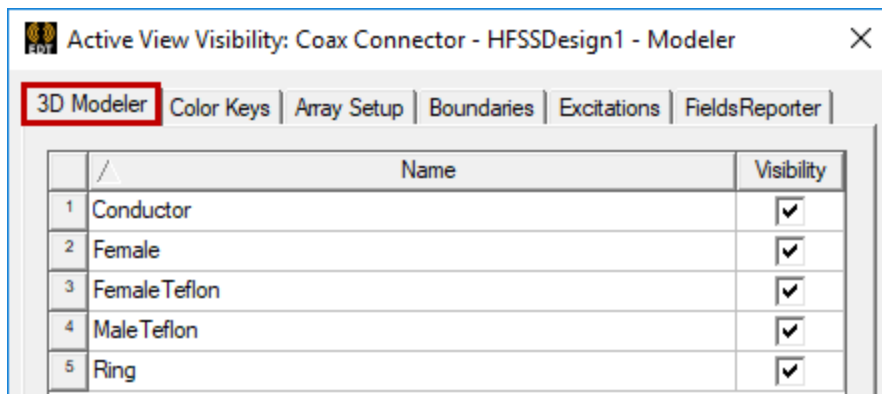

Figure 3-44: Active View Visibility Dialog Box – 3D Modeler Tab

3. On the **Excitations** tab, you can control **Visibility** of any applied excitations. In this case, wave ports *P1* and *P2*, and their associated terminals *P1_T1* and *P2_T2*.

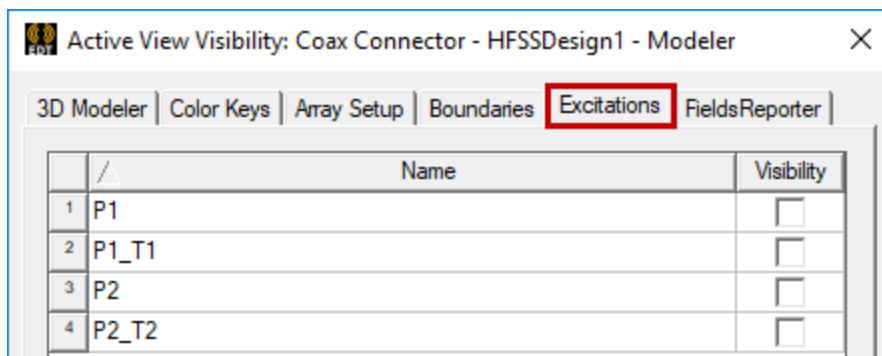

Figure 3-45: Active View Visibility Dialog Box – Excitations Tab

4. If you made any excitations visible, return them to invisible and then click **Done** to close the dialog box.
5. From the menu bar click **HFSS > Boundary Display (Solver View)**.

The *Solver View of Boundaries* dialog box appears.

Note:

HFSS identifies all the unique boundary conditions and ports to display.

6. On the dialog box, click the **Visibility** check box for boundaries that you wish to display.

Note:

If you double-click the fields under **Color**, you can change the color used to represent each boundary from the palette that appears. The boundaries of the non-conducting parts are listed as *outer* and the conductor boundaries are listed as *i_Conductor*.

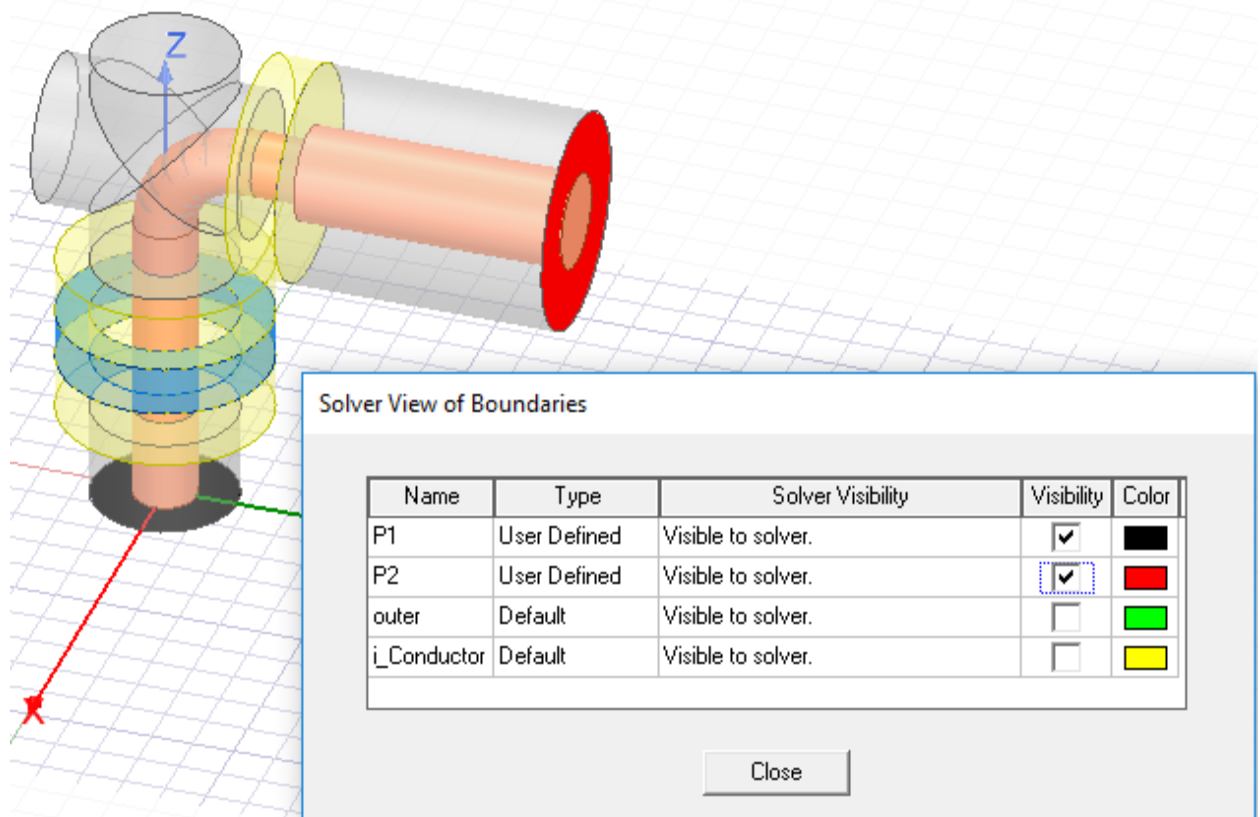

Figure 3-46: Solver View of Boundaries – P1 and P2 Boundaries Displayed

7. Click **Close**.

4 - Analyze the Model

This chapter contains the following topics:

- Add Solution Setup and Frequency Sweep
- Analyze the Coax Connector
- Review Solution Data
 - Review the Profile Tab
 - Review the Convergence Tab
 - Review the Matrix Data Tab
 - Review the Mesh Statistics Tab
- Port Field Display (Optional)
- Create Plot for S-Parameter Vs Pass
- Create dB S-Parameter Vs Frequency Plot
- Create S-Parameter Vs Frequency Plot
- Create Field Overlays
 - Modify Magnitude of Field Plot
 - Modify Terminal Excitation
 - Animate the Field Plot
- Net Visualization

Add Solution Setup and Frequency Sweep

1. On the **Simulation** ribbon tab, click **Setup > Advanced**:

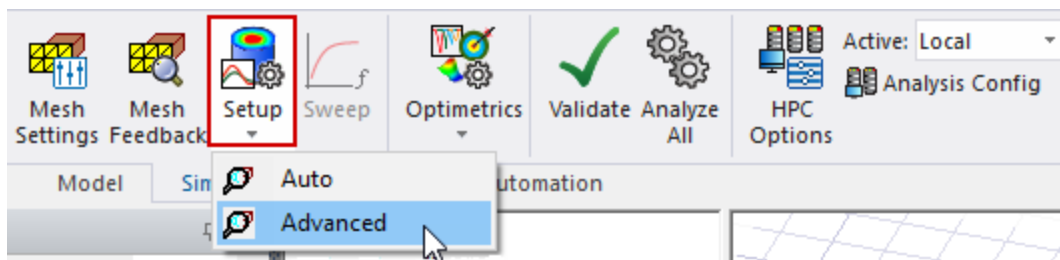

The *Driven Solution Setup* dialog box appears.

2. Edit the fields on the **General** tab as shown in the following figure:

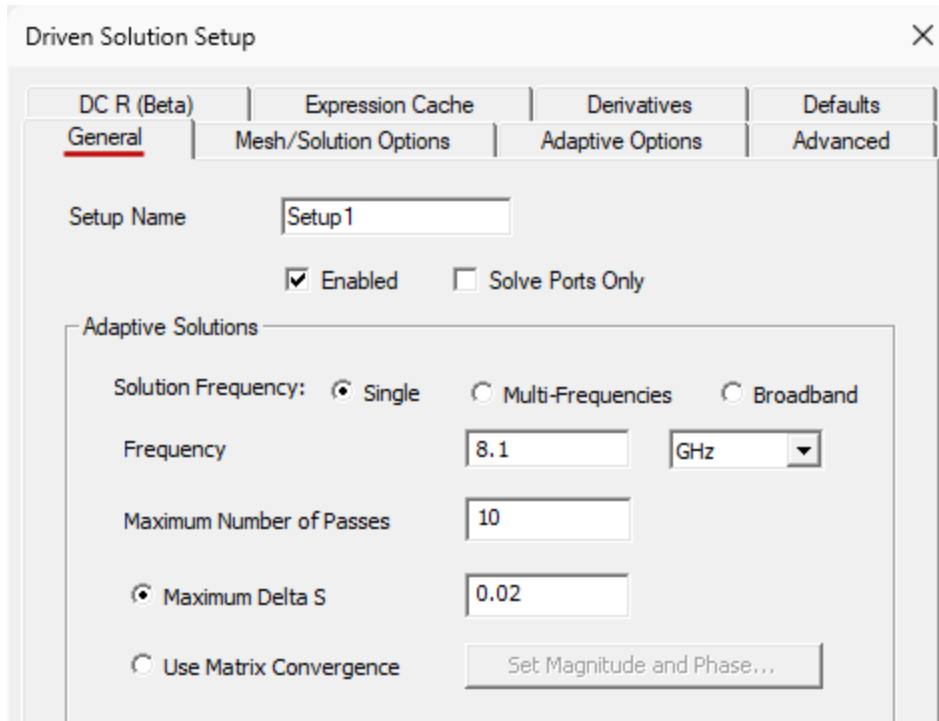

Figure 4-1: Driven Solution Setup Dialog Box – General tab

Note:

This dialog box defines how HFSS automatically generates an accurate mesh (based on the stopping criteria for the mesh adaptation process).

3. On the **Options** tab, set **Minimum Converged Passes** to **2** and click **OK**.

The solution setup is created, and **Setup1** appears under *Analysis* in the Project Manager.

Because ports have already been assigned, the *Edit Frequency Sweep* dialog box appears automatically upon completing the solution setup.

4. Edit the fields as shown in the following figure and click **OK**.

Note:

For the purpose of this exercise, the **Sweep Type** is **Fast**, even though the bandwidth of this solution is relatively wide. A fast sweep requires the least solution time and also has the advantage of providing field information (via the *Save Fields* option).

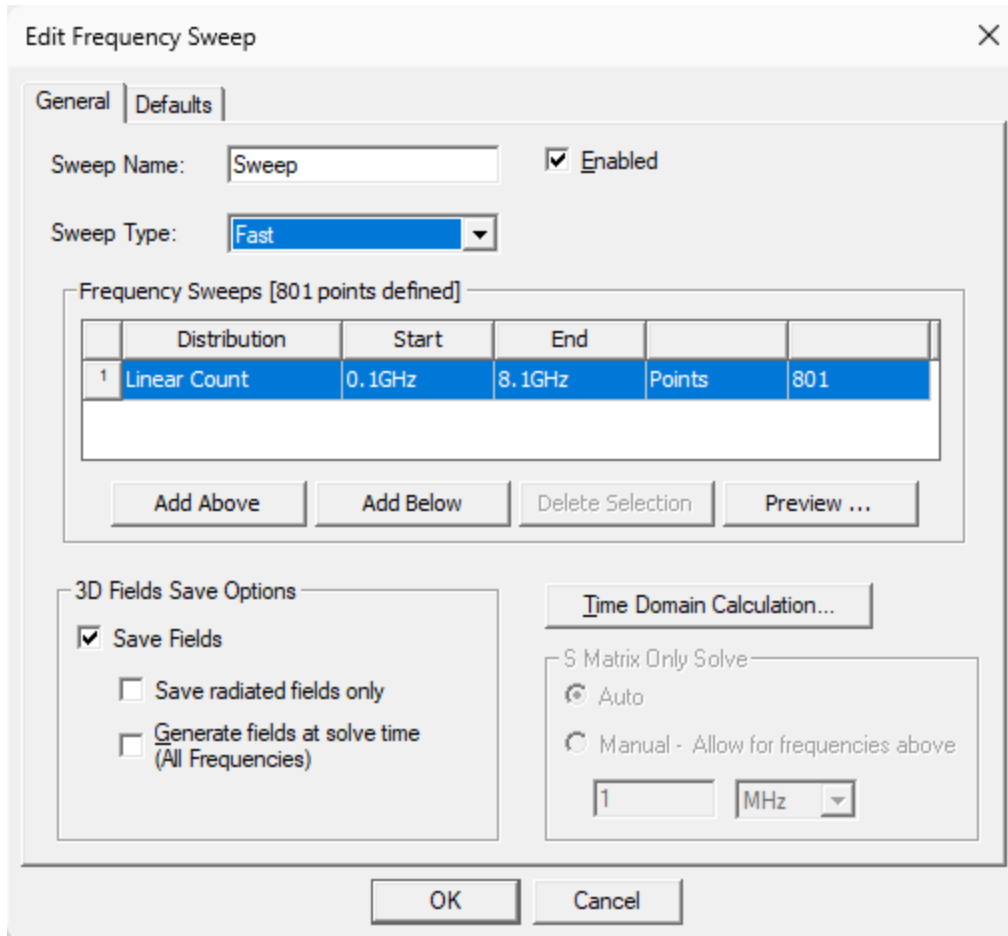
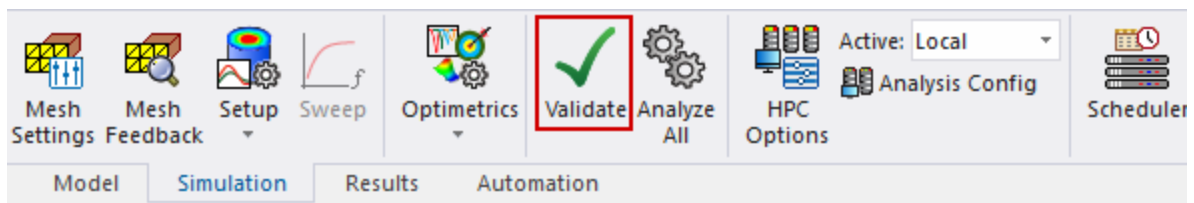

Figure 4-2: *Edit Frequency Sweep* Dialog Box – *General* Tab

Analyze the Coax Connector

The model has to pass the validation check to confirm your design is accurate before you analyze.

1. Click the **Validate** option on the **Simulation** ribbon tab.



The *Validation Check* dialog box appears.

Note:

The dialog box should resemble the following figure, with no warnings or errors reported.

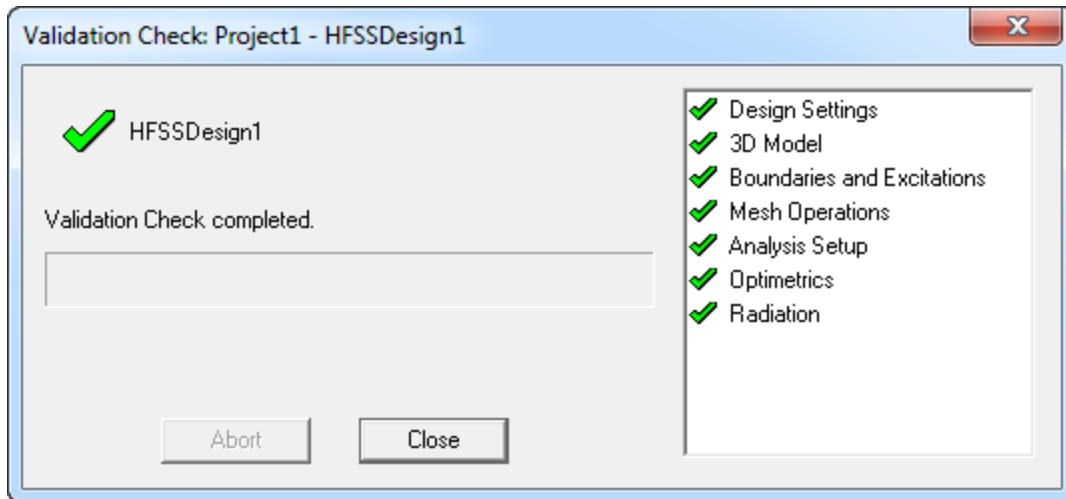
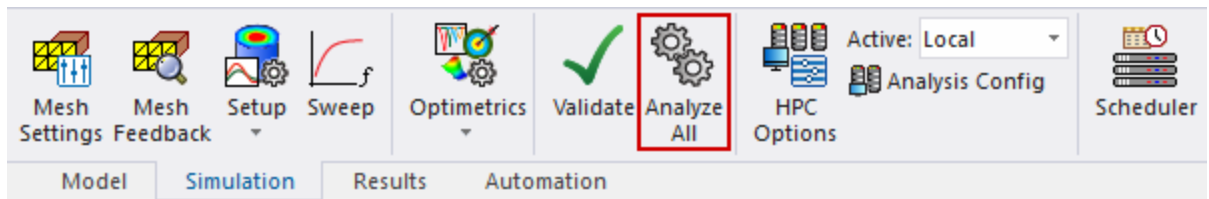

Figure 4-3: Validation Check Dialog Box

2. Click **Close**.
3. On the **Simulation** ribbon tab, click **Analyze All**:



:

HFSS solves the design and, if the simulation completes normally, the *Message Manager* window shows the notification, "*Normal completion of simulation on server: Local Machine.*" If you ran the solution on a remote server, the actual server name is reported in place of *Local Machine*.

Review Solution Data

1. On the **Results** ribbon tab, click **Solution Data**.

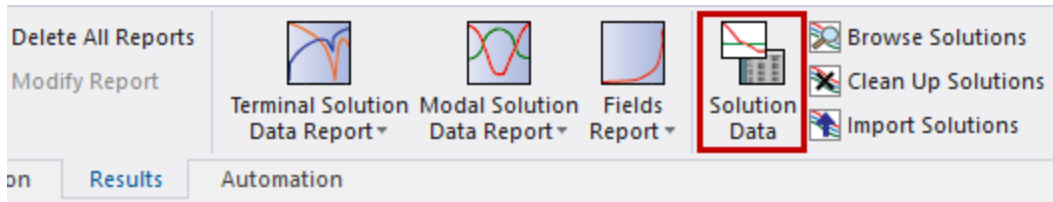

The *Solutions* dialog box appears.

Note:

Subsequent sections describe the tabs that constitute the *Solution* dialog box:

- Profile
- Convergence
- Matrix Data
- Mesh Statistics

Review the Profile Tab

1. On the *Solutions* window, click **Profile**.

Note:

After reviewing the information in this tab, keep the *Solutions* window open for reviewing the remaining tabs.

| Task | Real Time | CPU Time | Memory | |
|------------------|-----------|----------|--------|---|
| Initial Meshing | | | | Time: 10/14/2022 11:31:11 |
| Lambda Refine | 00:00:00 | 00:00:00 | 20.4 M | Tetrahedra: 4112, Cores: 1 |
| Simulation Setup | 00:00:00 | 00:00:00 | 51 M | Disk: 0 Bytes |
| Port Adapt | 00:00:00 | 00:00:00 | 63.3 M | Tetrahedra: 3068, Disk: 12.1 KB |
| Port Refine | 00:00:00 | 00:00:00 | 22.7 M | Tetrahedra: 4324, Cores: 1 |
| Initial Meshing | | | | Elapsed Time: 00:00:07 |
| Adaptive Meshing | | | | Time: 10/14/2022 11:31:19 |
| Adaptive Pass 1 | | | | Frequency: 8.1GHz |
| Simulation Setup | 00:00:00 | 00:00:00 | 53.7 M | Tetrahedra: 3274, Disk: 4.13 KB |
| Matrix Assembly | 00:00:00 | 00:00:01 | 84.2 M | Tetrahedra: 3274, P1 Triangles: 99, P2 Triangles: 115, Disk: 71.5 K |
| Matrix Solve | 00:00:00 | 00:00:02 | 132 M | Type: DCS, Cores: 12, Matrix size: 19608, Matrix bandwidth: 17.7, I |
| Field Recovery | 00:00:00 | 00:00:00 | 132 M | Excitations: 2, Disk: 1.17 MB |
| Data Transfer | 00:00:00 | 00:00:00 | 86.9 M | Adaptive Pass 1 |

Figure 4-4: Solutions Window – Profile Tab

The *Profile* tab of the *Solutions* window shows you a synopsis of the simulation process. The information on this tab includes the following:

- Mesh creation and refinement
- Adaptive meshing and adaptive passes
- Simulation setup
- Port adaptation
- Matrix assembly
- Solver data
- Field recovery (extraction of the electromagnetic field)
- Data transfer
- Frequency sweep (generation of S, Y, and Z parameter data)
- Solution process and total solution time (summary)

For each reported phase of the analysis, the Real Time, CPU Time, and additional applicable data are reported.

The more highly refined the mesh (that is, the higher the number of tetrahedral elements), the more accurate the HFSS solution of the design will be. However, a greater number of tetrahedra requires more computational resources (that is, CPU time and memory) to solve. Adaptive mesh

refinement is applied locally, only where required, thus balancing accuracy and computing resources.

Review the Convergence Tab

1. On the **Solutions** window, click **Convergence**.

The table showing convergence data is displayed.

Note:

After reviewing the information in this tab, keep the *Solutions* window open for reviewing the remaining tabs.

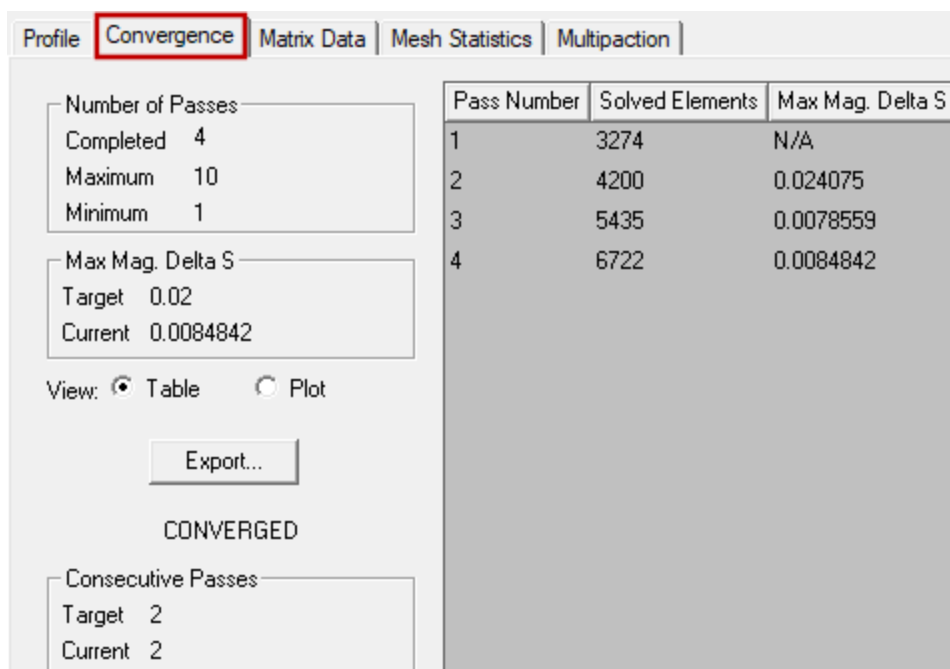

Figure 4-5: Solutions Window – Convergence Tab

Notice how element count increases with each adaptive pass (due to mesh refinement). The *Max Mag. Delta S* column shows the maximum change in the S-matrix magnitude at each pass, which is used as the stop criterion. When this value is less than the prescribed tolerance in the solution setup (*Maximum Delta S*) for as many consecutive passes as dictated (*Minimum Converged Passes*), mesh adaptation ceases. The solution is deemed to be sufficiently accurate, and the solution process proceeds to its conclusion.

2. Click the **Plot** radio button.

A graph of the convergence data is displayed.

3. Select the X and Y axes for your plot from the drop-down menu.

The plot of *Max Mag. Delta S* versus *Pass Number* appears:

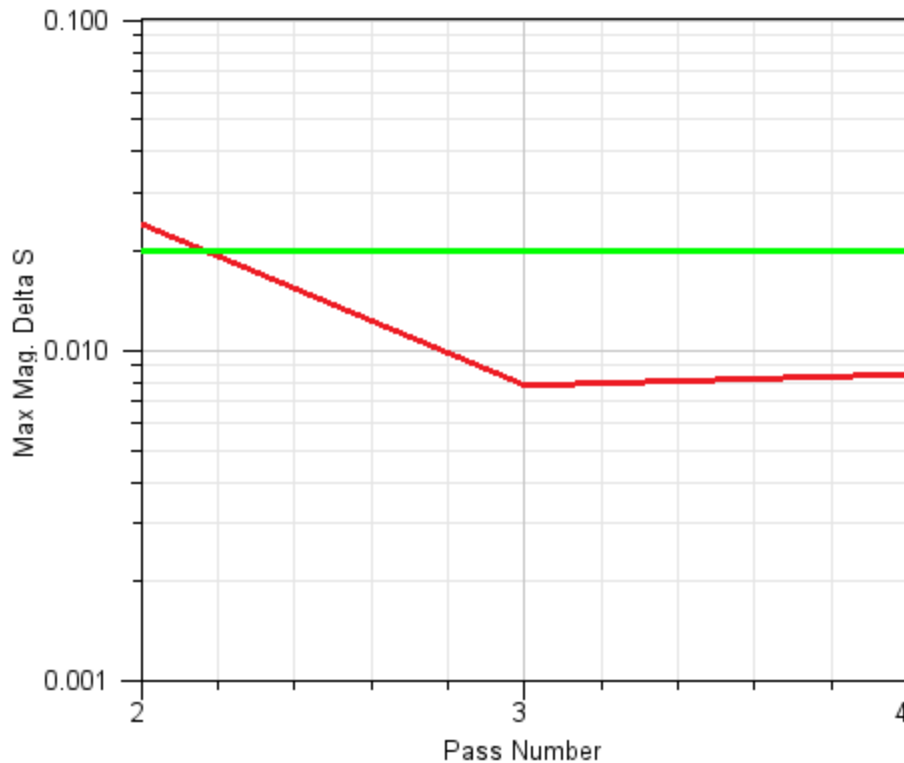

Figure 4-6: Convergence Graph

Review the Matrix Data Tab

1. On the **Solutions** window, click **Matrix Data**.

Note:

After reviewing the information in this tab, keep the *Solutions* window open for reviewing the remaining tab.

2. Select **Display All Frequencies**.

The *P1_T1* and *P2_T2* S-matrix values are tabulated for each frequency in the specified sweep.

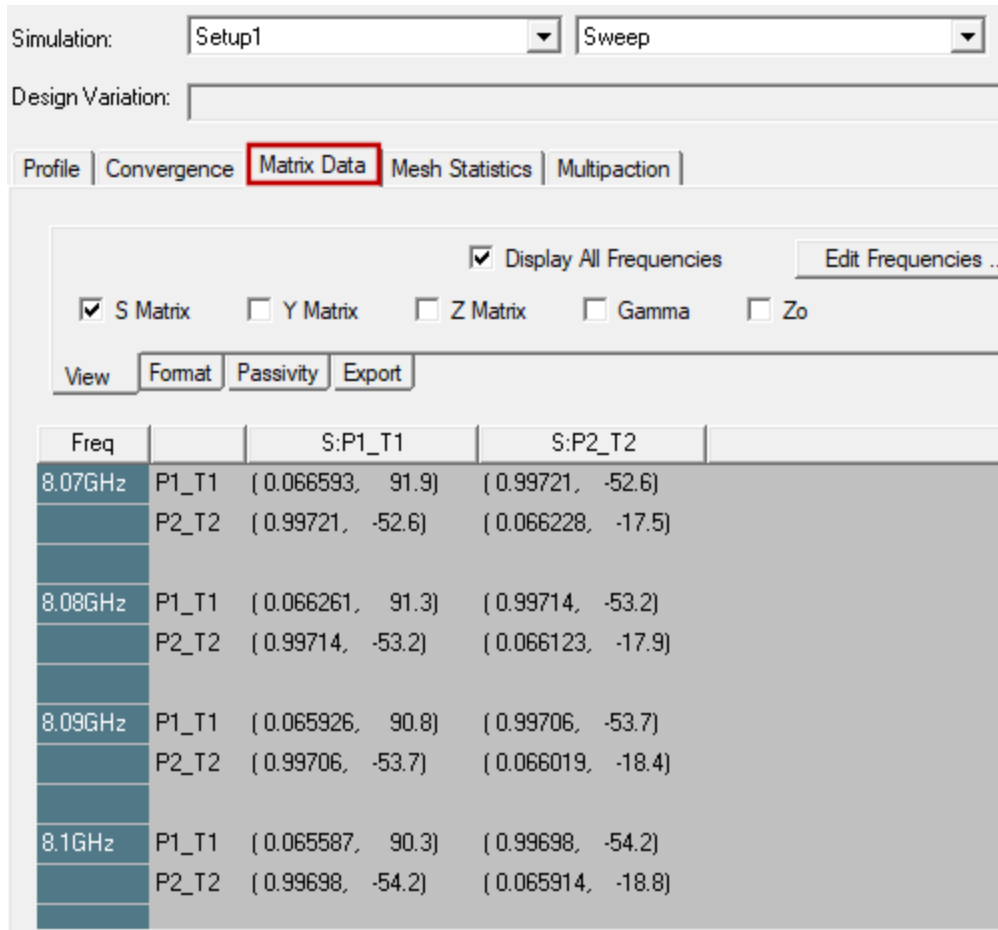

Figure 4-7: Solutions Window – Matrix Data Tab

Note:

For a real-time update of the Matrix Data while a solution is still running, choose **Setup1** and **Last Adaptive** from the **Simulation** drop-down menus.

Review the Mesh Statistics Tab

1. On the *Solutions* window, click **Mesh Statistics** for information about the tetrahedra that were solved.

| | Num Tets | Min edge length | Max edge length | RMS edge length | Min tet vol | Max tet vol | Mean tet vol | Std Devn (vol) |
|--------------------------------|----------|-----------------|-----------------|-----------------|----------------|---------------|----------------|----------------|
| Total number of elements: 7882 | | | | | | | | |
| Conductor | 1160 | 0.0872547 | 0.541121 | 0.255597 | 7.12365e-06 | 0.00515893... | 0.00031827 | 0.000478564 |
| Female | 4206 | 0.0100698 | 0.555868 | 0.225815 | 1.79796e-09 | 0.00248407... | 0.000356138... | 0.000311165 |
| FemaleTeflon | 794 | 0.0859365 | 0.310176 | 0.176454 | 2.43663e-05 | 0.00103306... | 0.000218384... | 0.000180208 |
| MaleTeflon | 1587 | 0.108353 | 0.351699 | 0.199617 | 3.54102e-05 | 0.00141619... | 0.00030113 | 0.000210995 |
| Ring | 135 | 0.20432 | 0.357949 | 0.284545 | 0.000196734... | 0.0014054 | 0.000748714... | 0.000277743 |

Figure 4-8: Solutions Window – Mesh Statistics Tab

The mesh statistics are listed separately for each part comprising the model, along with the total number of elements (reported above the table). The following mesh statistics are listed on this tab:

- Minimum, maximum, and RMS tetrahedra edge lengths
- Minimum, maximum, and mean tetrahedra volume
- Standard deviation of the tetrahedra volume.

Note:

You can click and drag the column heading borders to resize any column width. You can also resize the *Solutions* window's overall size.

2. Click **Close**.

Port Field Display (Optional)

The port field display is useful for diagnosing problems with wave port definitions. The visualization of the electric fields for the port's modes can help identify problems with port definitions, such as an incorrectly defined vector on the port.

Complete the following steps to see the electrical field patterns displayed on the model.

1. Under **Port Field Display > P1** in the *Project Manager*, select **P1_T1**.

A vector plot of the electrical field is overlaid on the *P1* port:

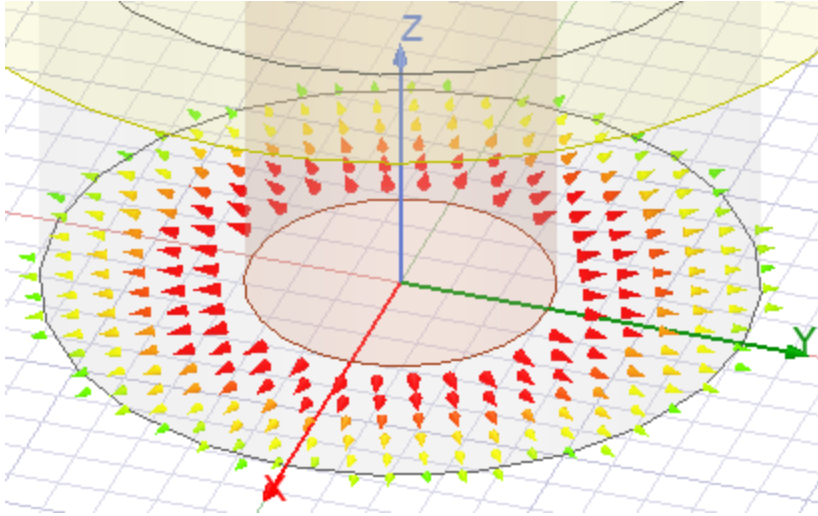

Figure 4-9: Port Field Display for P1_T1

2. Under **Port Field Display > P2** in the *Project Manager*, select **P2_T2**.

A vector plot of the electrical field is overlaid on the *P2* port:

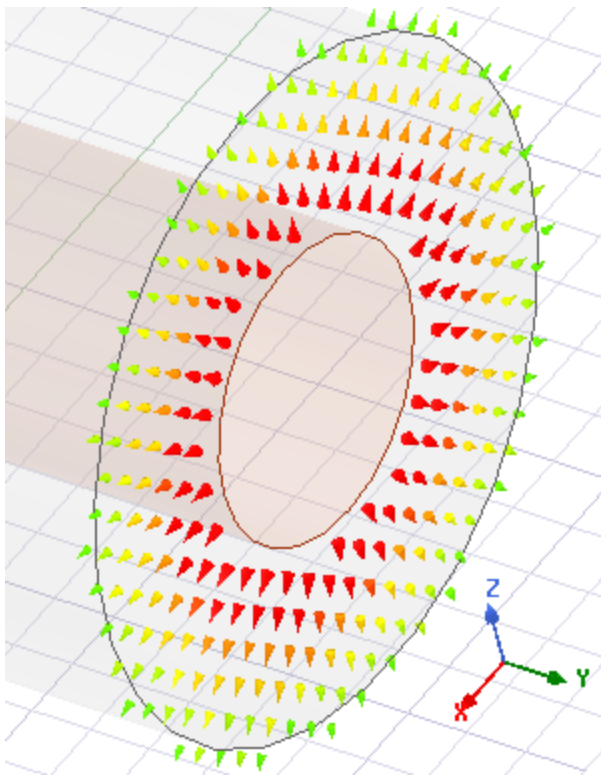

Figure 4-10: Port Field Display for P2_T2

Note:

For any project if you want to check the patterns and verify whether your excitations are accurately assigned, use this feature.

Create S-Parameter versus Pass Plot

You can generate reports to further study the simulation results.

Note:

If you create this report before or during the solution process, the displayed results are updated in real-time.

1. From the **Results** ribbon tab, click  **Terminal Solution Data Report** >  **2D**.

The *Report* dialog box appears.

2. Edit the fields in the *Report* dialog box as shown in the following figure:

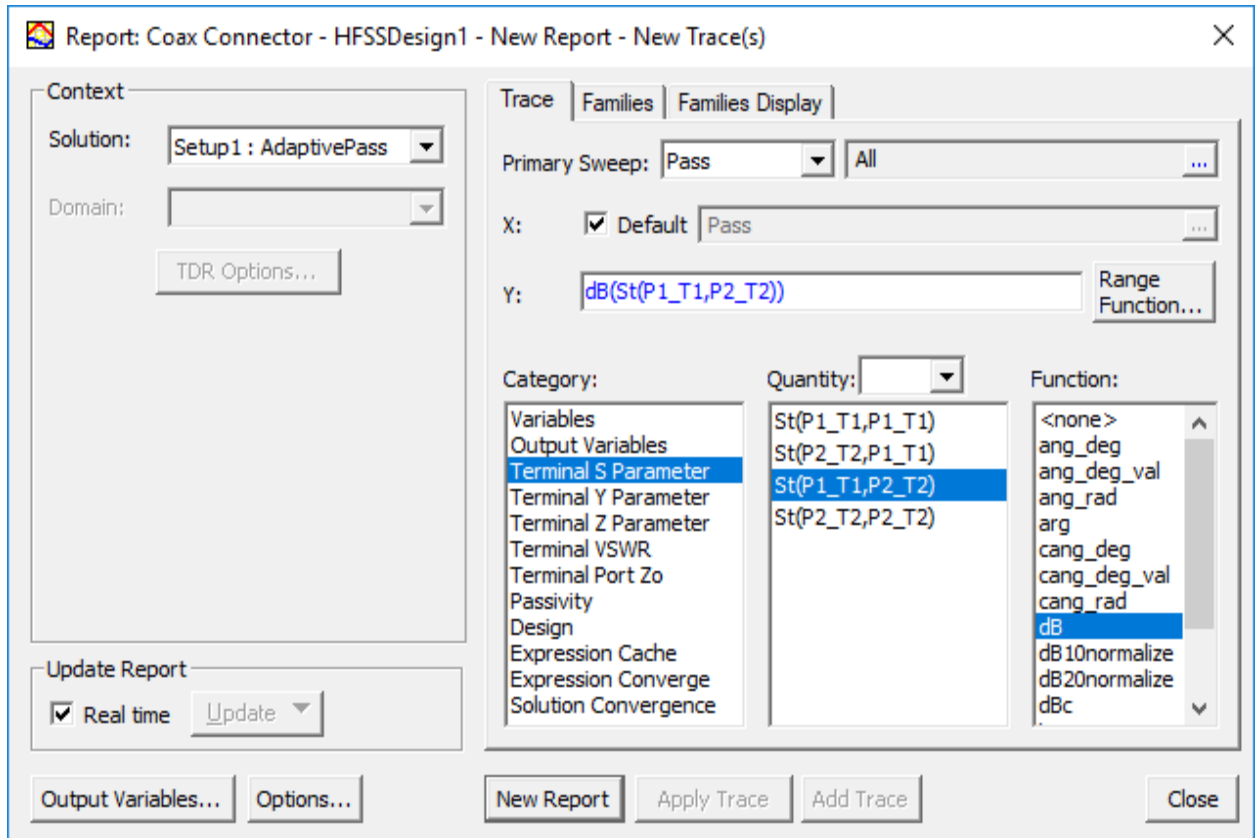

Figure 4-11: Report Dialog Box, S-Parameter vs. Pass

3. Click **New Report** but leave the *Report* dialog box open.

The plot is generated:

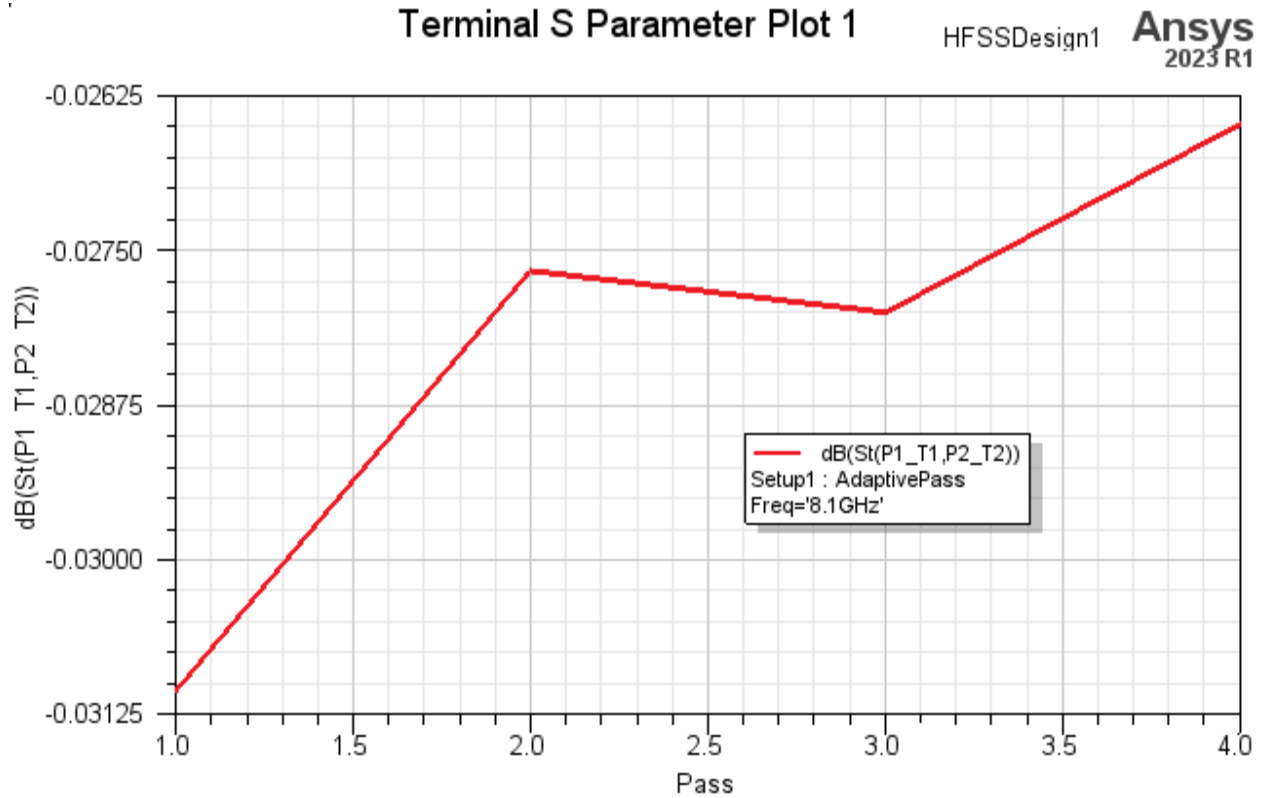

Figure 4-12: S-Parameter vs. Pass Plot

Create S-Parameter (dB) versus Frequency Plot

The *Report* dialog box should still be open from the prior procedure. Continue using it to create a second plot.

1. Edit the fields as shown in the following figure:

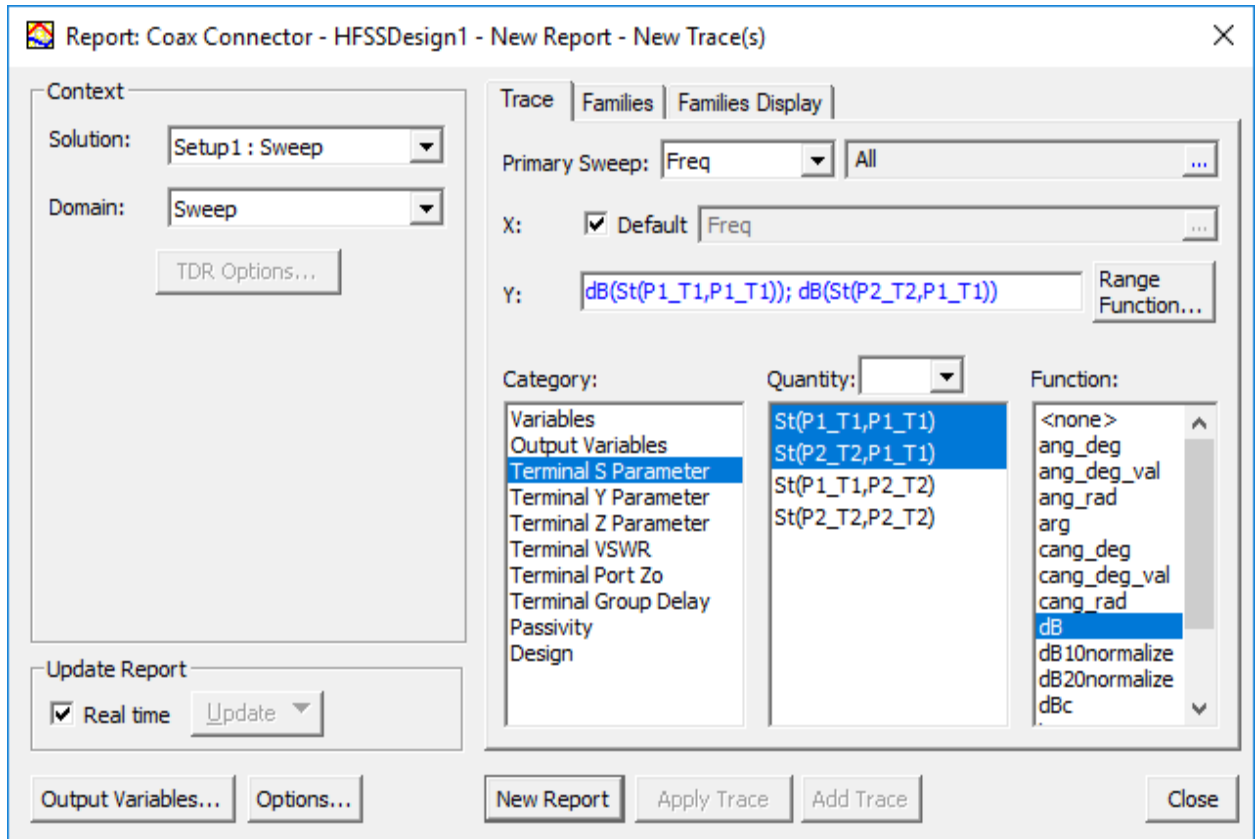

Figure 4-13: Report Dialog Box, S-Parameter (dB) vs. Frequency

2. Click **New Report** but leave the *Report* dialog box open.

The second plot is generated:

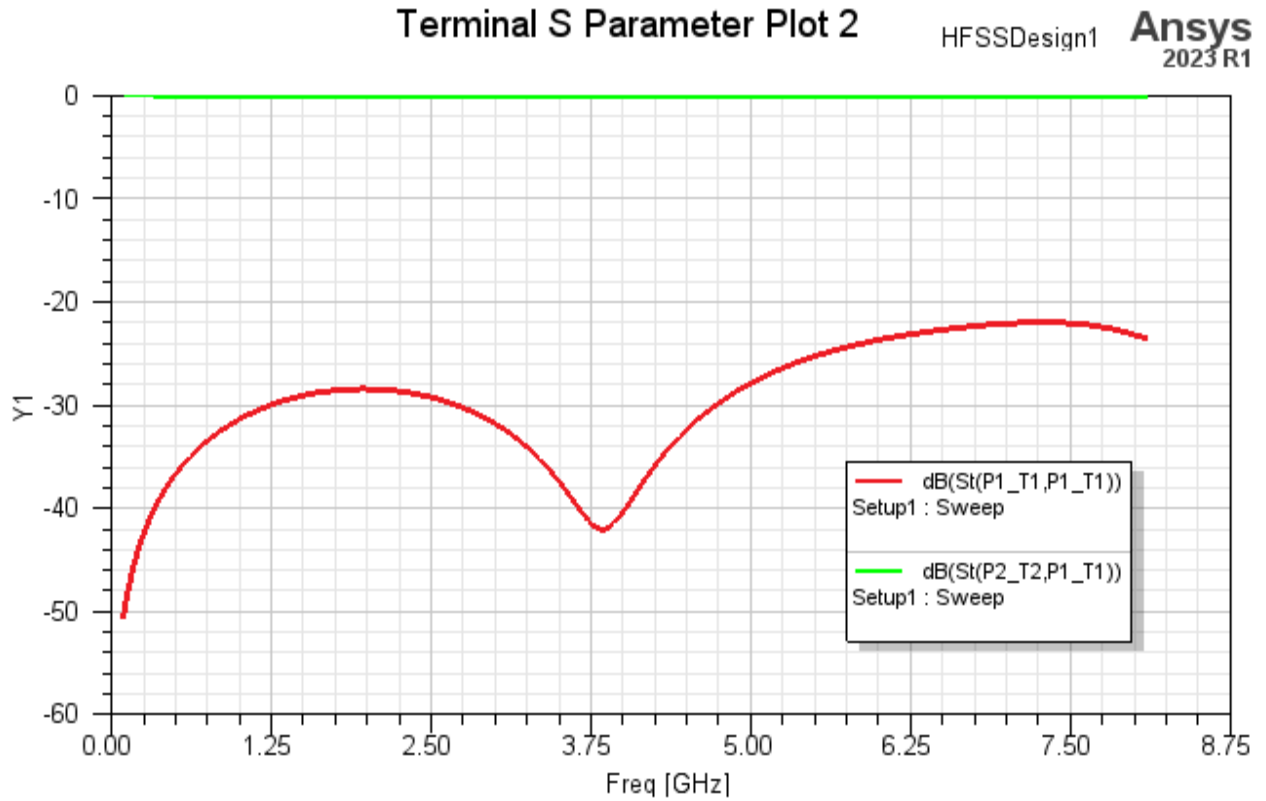

Figure 4-14: S-Parameter (dB) vs. Frequency Plot

Create S-Parameter (Angle) versus Frequency Plot

The *Report* dialog box should still be open from the prior procedure. Continue using it to create a third plot.

1. Edit the fields as shown in the following figure:

Note:

Only the *Function* changes relative to the previous plot.

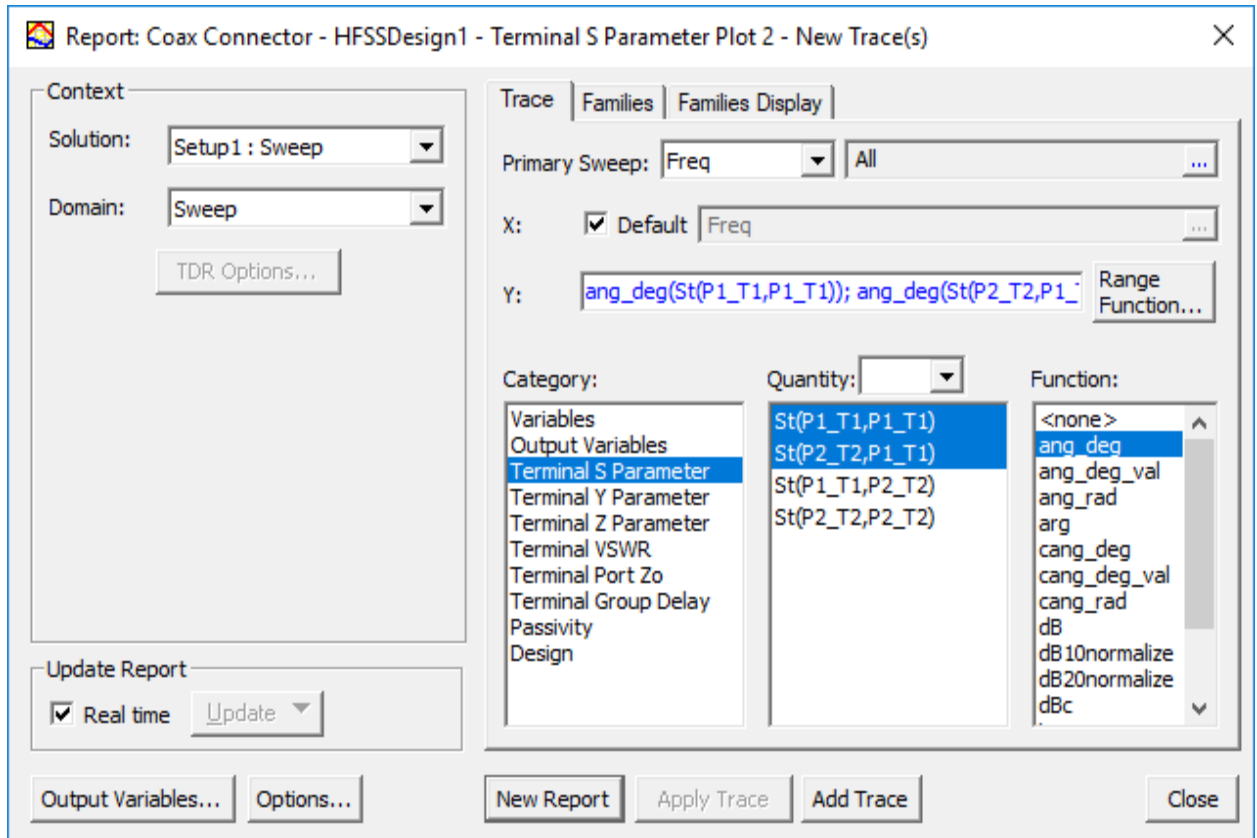

Figure 4-15: Report Dialog Box, S-Parameter (Angle) vs. Frequency

2. Click **New Report** and **Close**.

The third plot is generated:

Terminal S Parameter Plot 3

HFSSDesign1 **Ansys**
2023 R1

Figure 4-16: S Parameter (Angle) vs. Frequency Plot

Create Electric Field Overlay

On a selected cross-section of the model (specifically, along the global YZ plane), create a planar overlay of the electric field.

1. If your plot window is maximized, use the **Window** menu to return to the **Modeler** window, or minimize any windows that are in front of it.
2. In the *History Tree*, expand **Planes** and select **Global:YZ:**

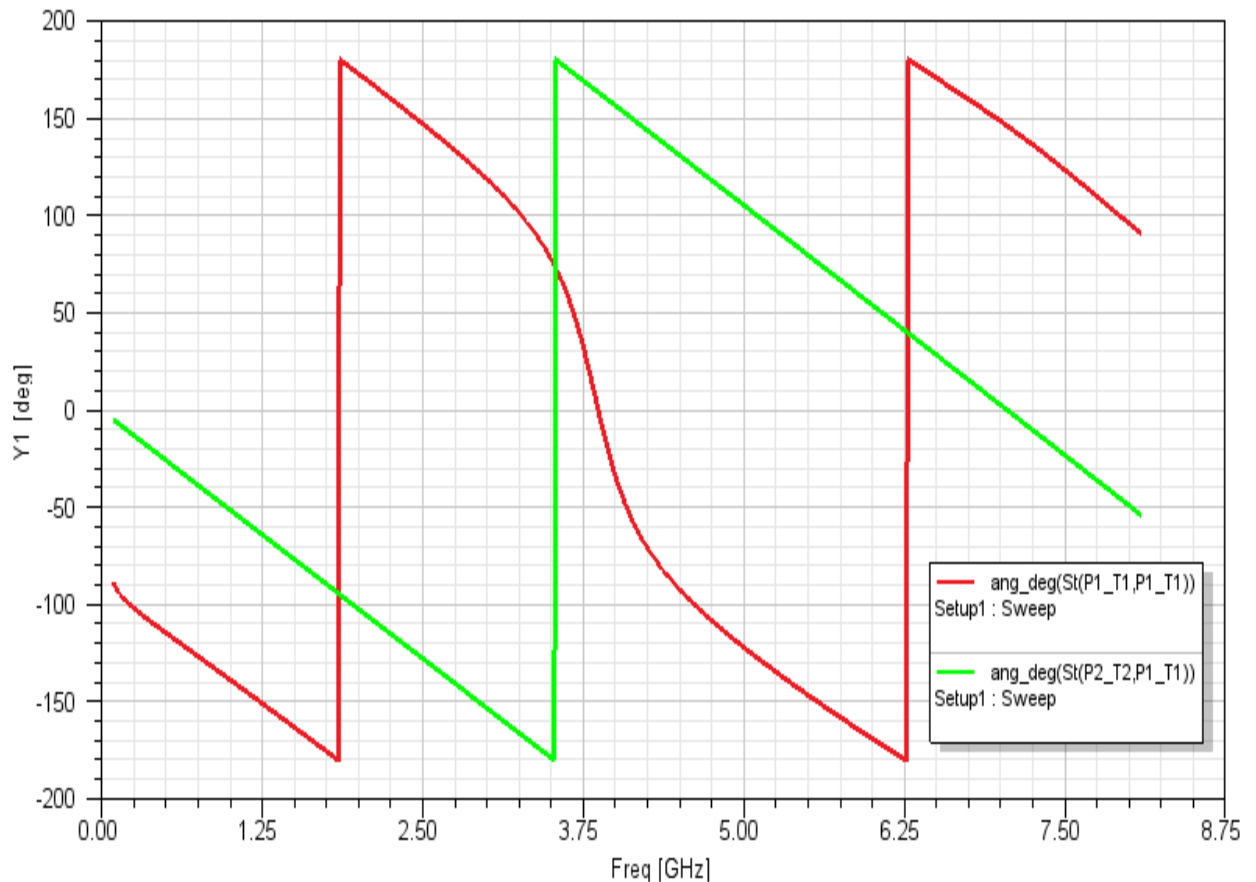
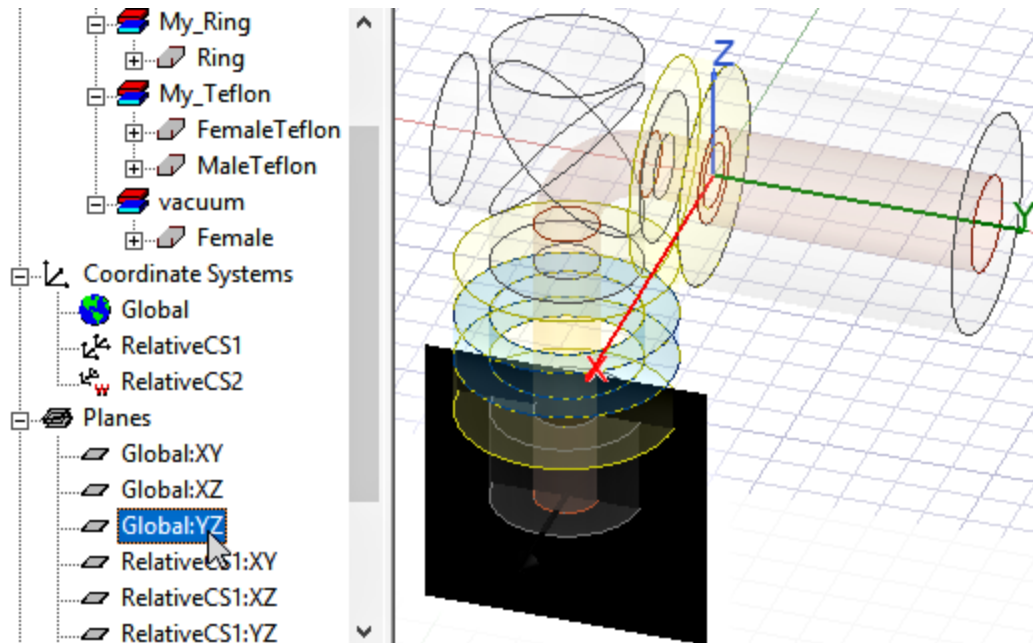

Figure 4-17: Selecting the Global:YZ Plane

3. Right-click in the Modeler window and select **Plot Fields > E > Mag_E** from the short-cut menu.

The *Create Field Plot* dialog box appears.

4. Edit the fields as shown in the following figure:

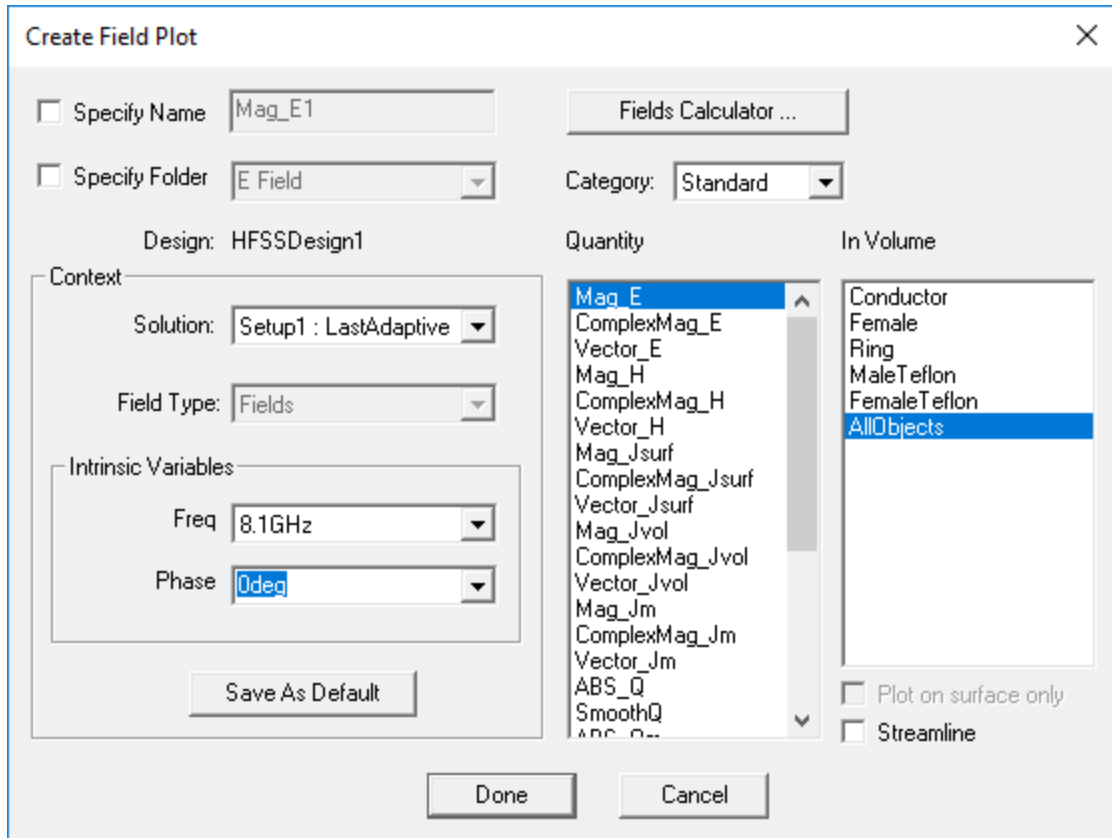

Figure 4-18: Create Field Plot Dialog Box

5. Click **Done**.

The field overlay is created.

6. On the **Model** ribbon tab, click **Orient** > **Front (-X)**.
7. To clean up the view a little bit, select **Field Overlays** > **E Field** > **Mag_E1** in the Project Manager.

While the overlay is selected in the Project Manager, the shading of the model's parts is partially suppressed. That is, the part transparency is increased.

Your model should resemble the figure below:

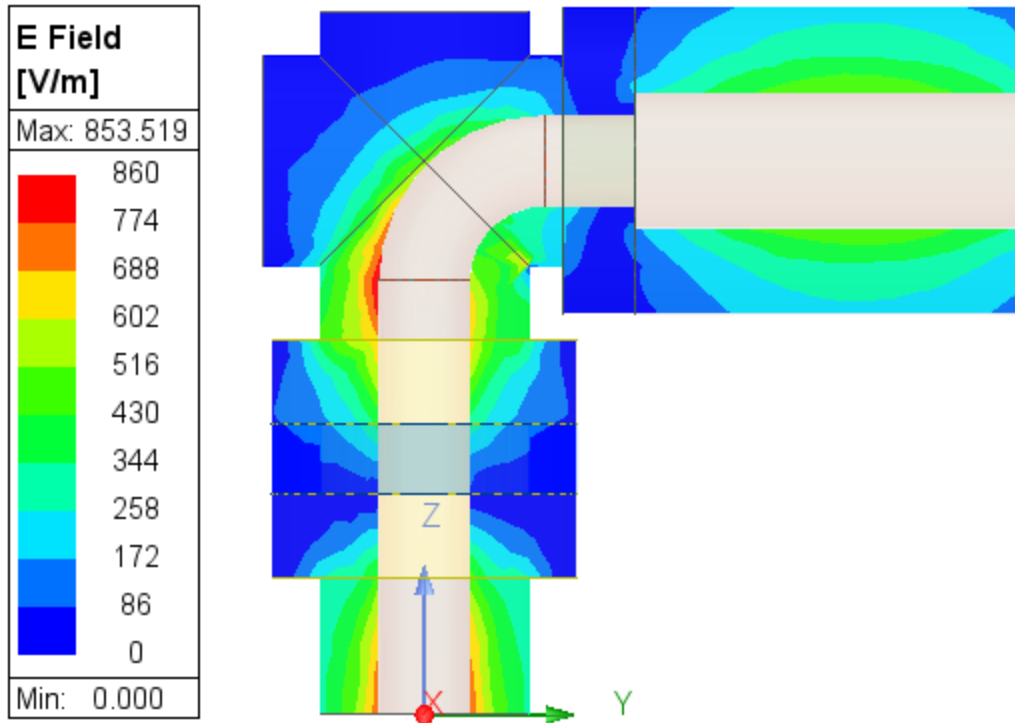

Figure 4-19: Electric Field Overlay

Modify Magnitude of Field Plot

1. Double-click within the border of the plot legend.

The *E Field* dialog box appears.

2. Click the **Scale** tab and edit the fields as shown in the following figure:

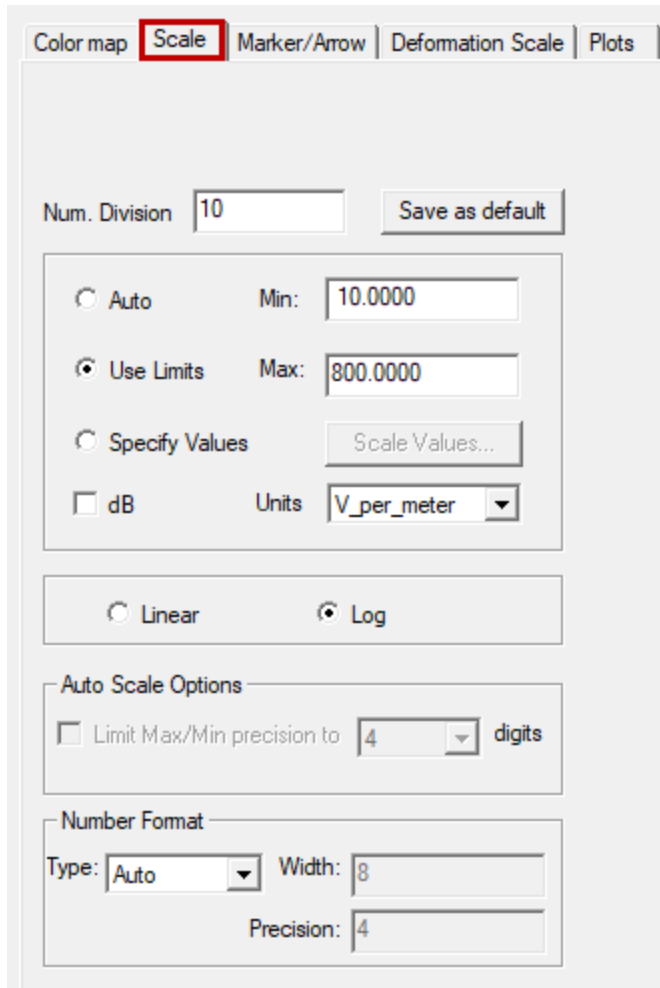

Figure 4-20: *E Field* Dialog Box – Scale Tab

3. Click **Close**.

The legend is revised to show a logarithmic progression between a minimum of 5 V/m and a maximum of 815 V/m. The contour plot colors are adjusted accordingly.

Modify Terminal Excitation

1. From the menu bar, click **HFSS > Fields > Edit Sources**.

The *Edit post process sources* dialog box appears.

2. Under the **Spectral Fields** tab of the dialog box, make the following changes:
 - a. For the *Terminal Excitation Type*, select **Total Voltage**.
 - b. In the **P2_T2** row of the table, select the **Terminated** option.

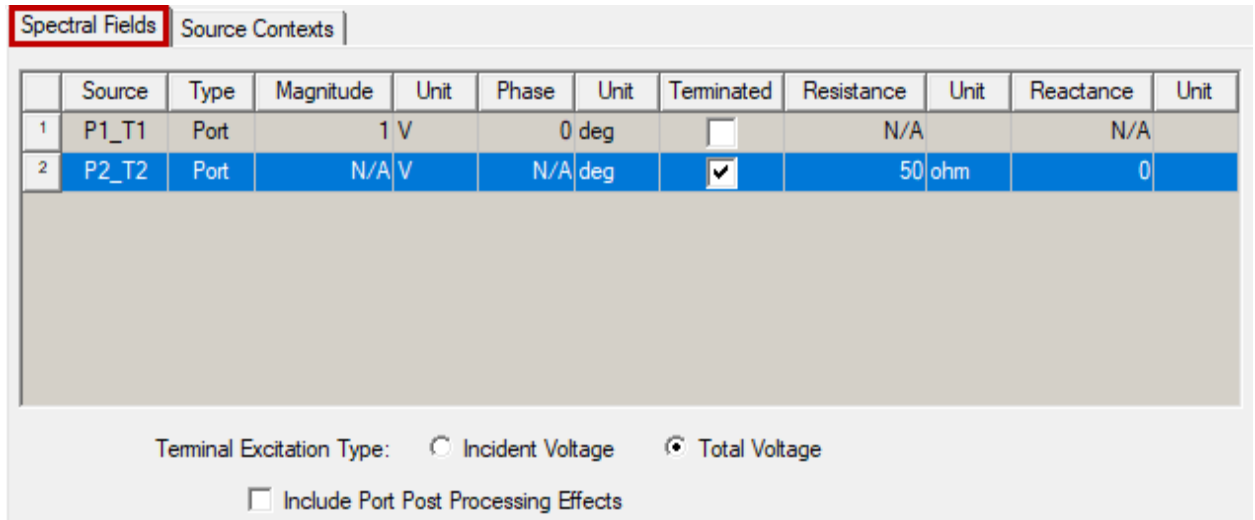

Figure 4-21: Edit Post Process Sources Dialog Box – Spectral Fields Tab

3. Click **OK** to update the plot.

Animate the Field Plot

1. Under *Field Overlays > E Field* in the *Project Manager*, right-click **Mag_E1** and select **Animate**.
2. In the *Create Animation Setup* dialog box that appears, accept the default settings and click **OK**.

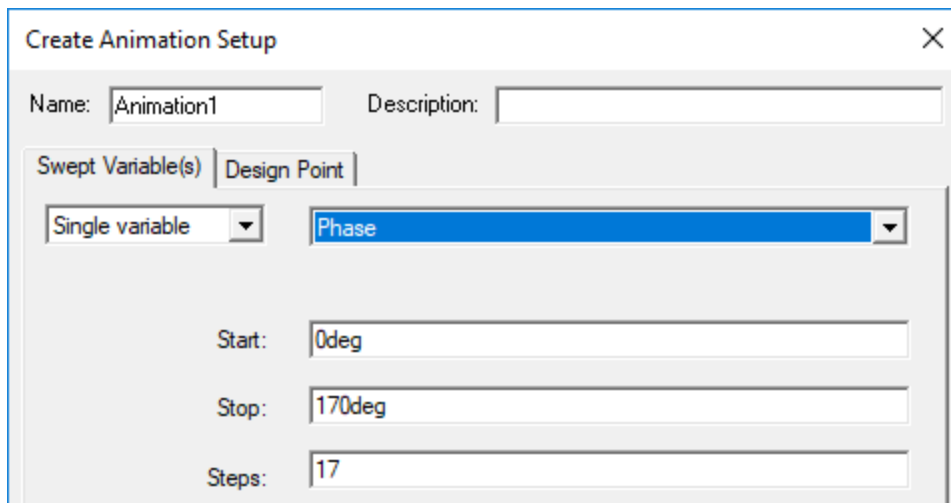

Figure 4-22: Create Animation Setup Dialog Box

The *Animation* dialog box appears, and the E field overlay on the model is animated.

3. Use the controls in the *Animation* dialog box to change the animation speed, stop and start the animation, or to reverse the playback direction.

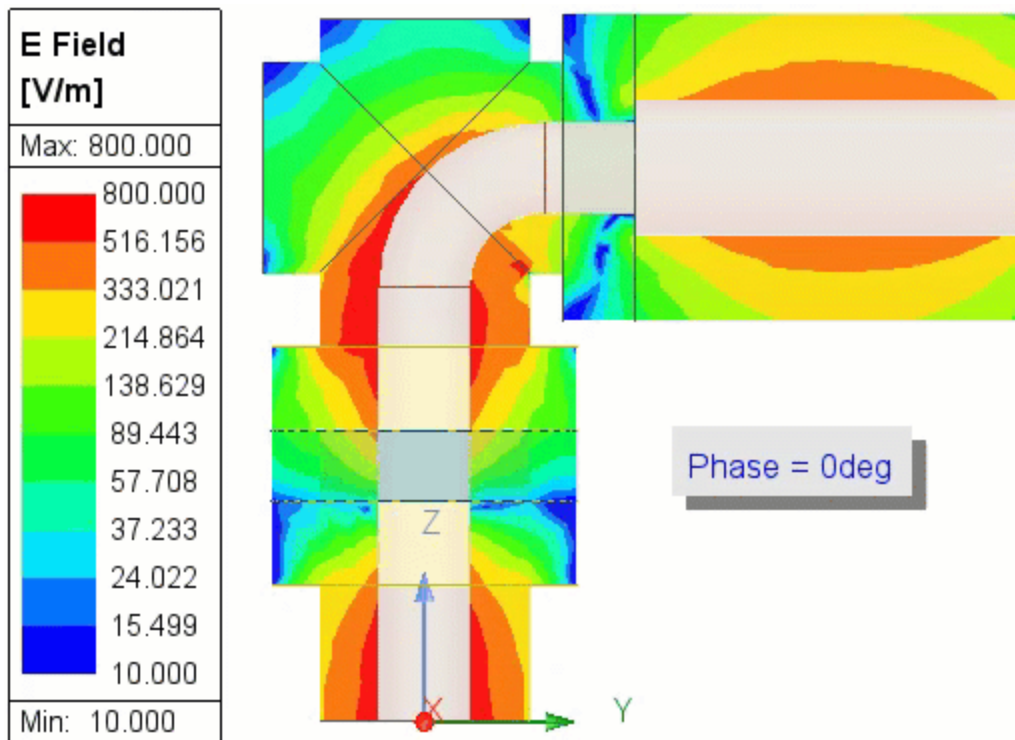

Figure 4-23: E Field Animation

4. Click **Close** when you're done viewing the animation.
5. Under *Field Overlays* > *E Field* in the Project Manager, right-click **Mag_E1** and deselect **Plot Visibility** in the shortcut menu to hide the electric field overlay.

Net Visualization

You can use the *Show Nets* command to visualize conducting nets and terminal associations for 3D conductors.

1. On the **Draw** ribbon tab, click **Grid** to toggle off the display of the drawing grid.
2. On the **Draw** ribbon tab, click **Orient** > **Trimetric** to restore the default orientation of the model view.
3. In the Project Manager, right-click **Excitations** and select **Show Nets** from the shortcut menu.

The *Net Visualization* dialog box appears.

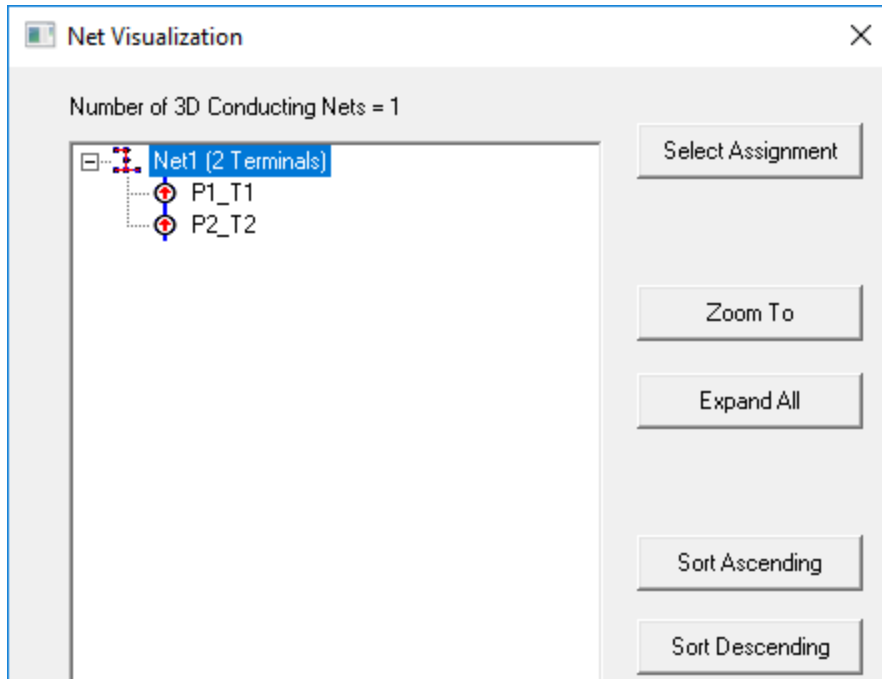

Figure 4-24: Net Visualization Dialog Box

4. Select **Net1** to visualize the associated conductor via a pattern overlaid on the model view:
5. Press **F6** to suppress shading for all objects for a better view of the net visualization.

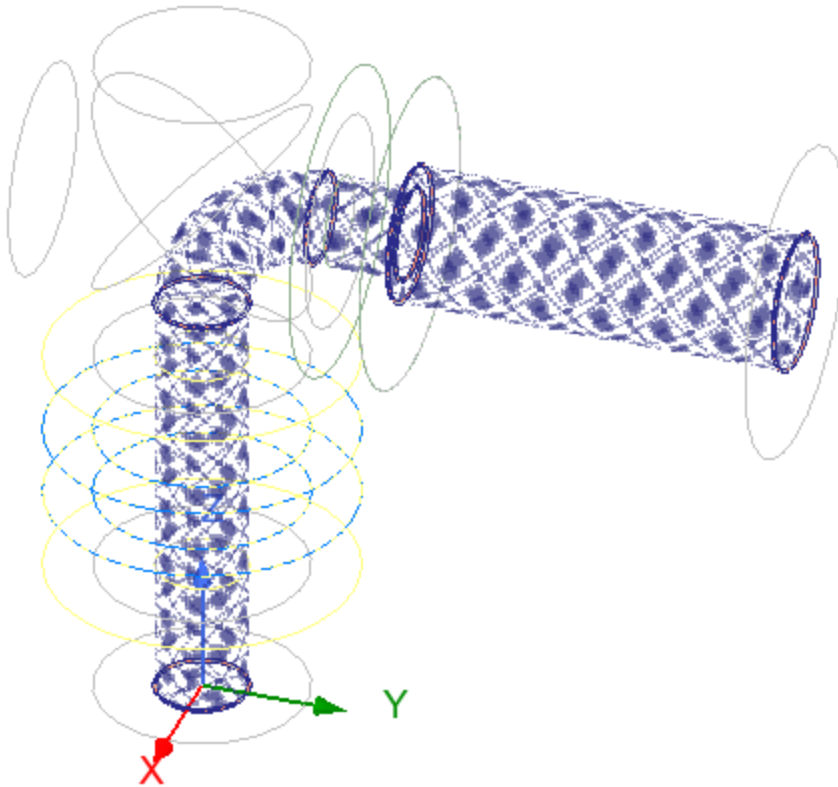

Figure 4-25: Visualization of Conductor Net1

6. Select **P1_T1** and **P2_T2** to see the associated terminals indicated on the model view:
7. Press **F7** to restore object shading.
8. Middle-click and drag the mouse to freely rotate the model viewpoint so that both terminal labels are visible.

The bottom terminal label is not visible until the face of the conductor is toward you:

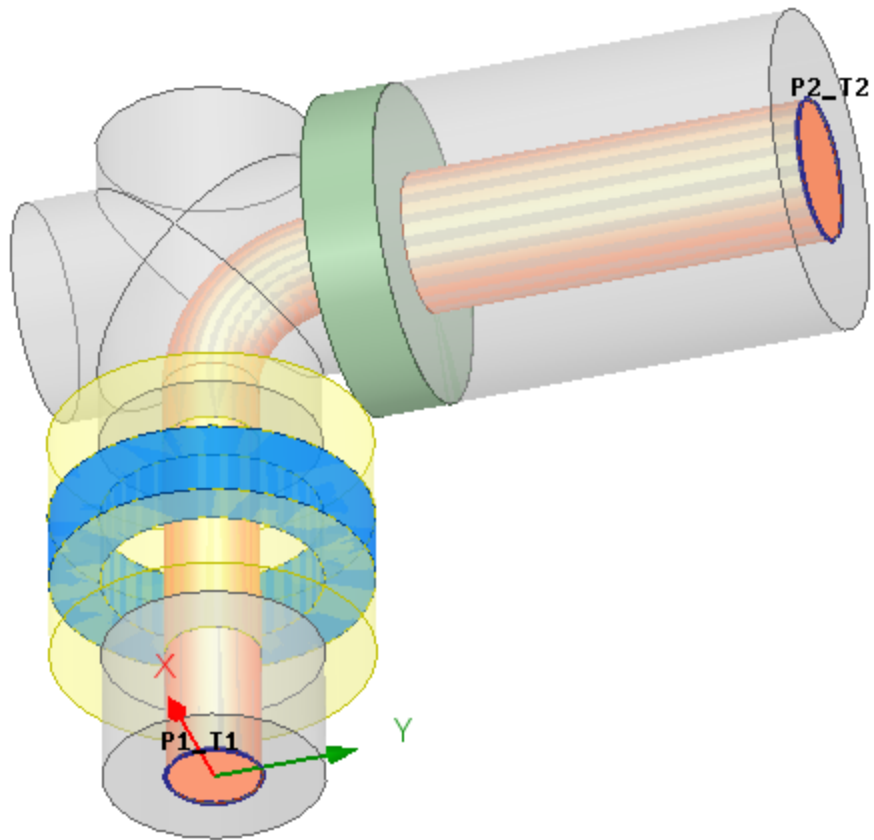

Figure 4-26: Conductor *Net1*'s Terminal *P2_T2*

9. Click **Close**.

5 - Optionally, Restore Current View Orientations

You have completed this getting started guide.

If you prefer to use the new view orientations implemented in version 2024 R1 of the Ansys Electronics Desktop application, clear the *Use Legacy View Orientation* option as follows:

1. From the menu bar, click **View > Options**.

The *3D UI Options* dialog box appears.

2. Ensure that **Enable Legacy View Orientation** is cleared:

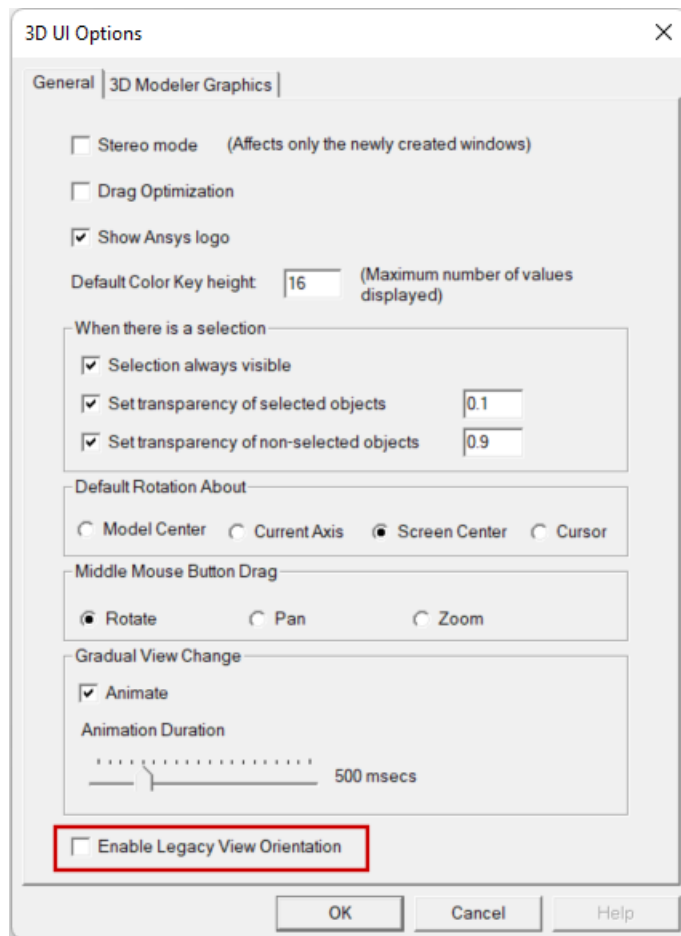

3. Click **OK**.

The settings in the 3D UI Options dialog box are global. Your choice is retained for all future program sessions, projects, and design types that use the 3D Modeler or that produce 3D plots of results.

You can now save and close this project.

Index

A

animation

 creating a phase animation 5-1

P

plots

 animating 5-1

R

reports

 animating 5-1, 5-1